

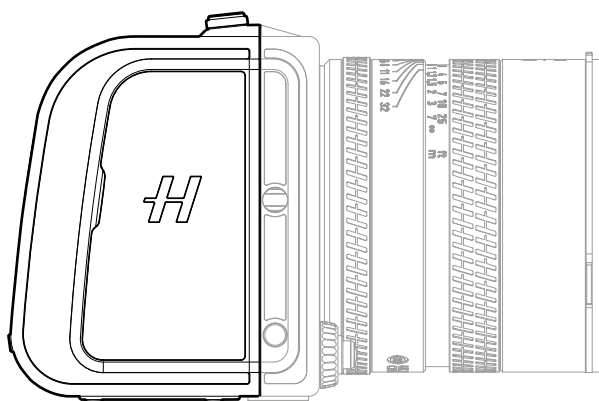

# *HASSELBLAD*

## CFV 100C

### User Manual

v1.0 2024.01



 **Searching for Keywords**

Search for keywords such as “battery” and “install” to find a topic. If you are using Adobe Acrobat Reader to read this document, press Ctrl+F on Windows or Command+F on Mac to begin a search.

 **Navigating to a Topic**

View a complete list of topics in the table of contents. Click on a topic to navigate to that section.

 **Printing this Document**

This document supports high resolution printing.

# CONTENTS

<b>1</b>	<b>PRODUCT PROFILE</b>	<b>11</b>
1.1	Introduction	12
1.2	Feature Highlights	12
	Powerful Compatibility	12
	907X Camera Body	12
	Hasselblad V System Film Cameras	12
	Technical Cameras	12
	100-Megapixel Medium Format BSI CMOS Sensor	13
	HNCS	13
	Phase Detection Autofocus	13
	Built-in 1TB SSD	13
	Tilting Touch Display	13
	Phocus Mobile 2 and Phocus	13
	High-Speed Transmission	14
1.3	907X & CFV 100C Specifications	15
	CFV 100C Digital Back	15
	907X Camera Body	17
	907X & CFV 100C	18
1.4	Charging	19
	How to Charge	19
	Charging Indicators	20
1.5	Inserting the Memory Card	21
1.6	Using CFV 100C with 907X	22
	Mounting CFV 100C and 907X	22
	Mounting the Lens	23
1.7	Using CFV 100C with Other Cameras	24
	Mechanical Shutter	24
	Electronic Shutter	25
	Mounting CFV 100C and Camera	25
	Using CFV with 500 Camera	26
	Start Live View with 500C or 500C/M Camera	26
	Start Live View with 501 or 503 Camera	27
	Remote Control of 503CW with Winder CW	27
	Using CFV with 200 or 2000 Camera	28
	Start live view	28

Using CFV with SWC Camera	29
Start live view with a SWC camera	29
Using CFV with EL Camera	30
Start Live View with EL Camera	30
Remote Control of EL Camera	31
Using CFV with ELD Camera	32
Start Live View with ELD Camera	32
Using CFV with Flash Sync on Camera	33
Start Live View	33
Using Camera with Electronic Shutter	34
Using with Flash	34
Using 500 Camera	34
Using Modified 200 Camera with C Type Lens	34
Using Modified 200 Camera with F Type Lens	35
Using Cameras with Any (Flash Sync) Setting	35
1.8 Mounting the Hot Shoe Adaptor	36
<b>2 FUNCTIONS</b>	<b>37</b>
2.1 Overview	38
CFV 100C Digital Back	38
907X Camera Body	42
2.2 Touch Display	43
Touch Display Operations	43
Touch Controls	43
Button and Scroll Wheel Controls	44
Screen Switch	45
Live View	47
Exposure Information Display	47
Exposure Information + Histogram Overlay	51
Exposure Information + Grid Overlay	51
Exposure Information + Distance Scale Overlay	51
Exposure Information + Spirit Level Overlay	51
Control Screen	52
Enter/Exit Control Screen	53
Locked Parameters on Control Screen	54
Settings on Control Screen	55
Browse Mode	60
2.3 Exposure Modes	61

Selecting Exposure Mode	61
Manual Exposure	62
Automatic Exposure	63
Auto Exposure Lock	63
2.4 Focus Modes	64
Selecting Focus Mode	64
Auto Focus	66
Focus Point	67
Autofocus Single	68
Face Detection	68
Manual Focus	71
Manual Focus in Live View	71
Enabling MF Assist	71
Focus Peaking	72
Auto Zoom	73
Focus Indicator	74
Moving and Adjusting Focus Point	75
2.5 Drive Modes	76
Selecting Drive Mode	76
Single	77
Continuous	77
Self-Timer	77
Interval	78
Exposure Bracketing	79
Focus Bracketing	80
Step Size	82
2.6 Built-in SSD	84
Storing Files to SSD	84
Formatting SSD	84
Checking SSD Storage Status	84
Using the SSD as Mass Storage	84
2.7 Memory Cards	85
Storing Files to Memory Card	85
Formatting Memory Card	85
Checking Memory Card Storage Status	85
2.8 Image Browsing	86
Browsing Images	86
Standard Preview Mode	87

9 View Mode / 25 View Mode	87
Capture Details Mode	88
Separate Histogram RGB Mode	88
Luminance Histogram Mode	88
Luminance Histogram Exposure	89
Selecting Folder to Browse	90
Creating Folders	90
Image Rating	91
2.9 Lens Data Selection	92
<b>3 SETTINGS</b>	<b>93</b>
3.1 Main Menu	94
3.2 Exposure Settings	95
Exposure Compensation	95
Reset After Exposure	95
Reset After Reboot	95
Shutter Function	96
Electronic Shutter	96
True Exposure	96
Shutter Speed Limit	98
Auto ISO Limits	99
Exposure Simulation	99
Configuration	100
Exposure Lock	100
Increment Step Size	100
B/T Mode	100
Lens	101
3.3 Focus Settings	102
Autofocus	102
AF Point Size	102
Reset Focus Point	102
AF Results Sound	102
Manual Focus	103
MF Assist	103
Touch AF	103
Move AF Point	103
Touch	103
Joystick	103

3.4	Quality Settings	104
	Image Format	104
	Bit Depth	104
3.5	Crop Modes Settings	105
	Crop Mask	105
	Crop Mode	105
	Mask Opacity	105
	My Crop Modes	105
3.6	Flash Settings	106
	Sync	106
	Exposure Lock until Flash Ready	106
3.7	Camera Body Settings	107
3.8	Display Settings	108
	Screen Brightness	108
	Live View	108
	Variable Frame Rate	108
	Preview	109
	Show Preview	109
	Preview Time	109
	Overexposure Warning	109
3.9	Power Settings	110
	Display Off	110
	Power Off	110
	Power Off when Tethered	110
3.10	Storage Settings	111
	Destination	111
	Primary Slot	111
	Secondary Storage	111
	Info	112
	Format	112
3.11	Wi-Fi Settings	113
3.12	General Settings	115
	Touch	115
	Enable Touch	115
	Custom Buttons	116
	Custom Buttons	116
	Reset Custom Buttons	116

Custom Overlays	117
Combined	117
Custom Profiles	118
My Lenses	119
Spirit Level Calibration	120
Date & Time	122
Language & Unit	122
Language	122
Unit of Distance	122
Service	123
Firmware Update	123
Default Settings	124
File Counter	124
Log Data	124
Sensor Calibration	124
About	125
<b>4 PHOCUS MOBILE 2 AND PHOCUS</b>	<b>126</b>
4.1 Profile	127
4.2 Phocus Mobile 2 App	128
4.3 Phocus Software	129
Connecting to Computer	129
Professional Image Quality	130
Phocus and Hasselblad Capture Files	130
<b>5 APPENDIX</b>	<b>131</b>
5.1 Change From Foreign Language	132
5.2 ERROR MESSAGES	133
5.3 Clean the Sensor Filter	133
5.4 Clean the Lens Glass Surface	134
Remove Dust	134
Remove Smear	134
5.5 Clean the Digital Back	134
5.6 EV VALUE	135
5.7 Accessories	137
XH Lens Adapter	137
XH Converter 0,8	138



---

XV Lens Adapter	139
Tripod Mount Ring 75mm	139
XPan Lens Adapter	140
Battery Charging Hub	140
Release Cord X	141
Flash Sync Input Cable	141
Flash Sync Output Cable	141
Exposure Cable EL	141
Exposure Cable 503	141
V System Accessories	142

## USING THIS MANUAL

### LEGEND

 Import

 Hints and tips

### BEFORE USE

The following documents have been produced to help users safely operate and make full use of the product:

1. Safety Guidelines
2. Quick Start Guide
3. User Manual

Read the safety guidelines before use. Refer to the quick start guide for more information on assembly and basic features and functions. Refer to the user manual for more comprehensive information.

### GLOSSARY

In this user manual, a few terms are used:

**Tap:** This means to touch a value or icon on the display with the finger briefly. This only works with a bare finger or when special touch-display gloves are used.

**Double-tap:** Quickly tap the same location on the display within 1 second. This is mainly used to zoom in or out an image or Live View.

**Long-press:** Press and hold for 1 second.

**Swipe:** A swiping movement is when users press and hold the finger and slide in one direction. This is typically used when selecting a value from a list or when panning in a zoomed-in image.

**Spread:** Place two fingers on the display and move them apart. Typically used when zooming in.

**Pinch:** Place two fingers on the display with a distance between and move the fingers together. Typically used when zooming out.

**Tethering:** When the camera is connected to a computer with a USB cable or an iPad/iPhone with Wi-Fi.

## 1 PRODUCT PROFILE

## 1.1 INTRODUCTION

The all-new HASSELBLAD™ CFV 100C medium format digital back can be used on most V System cameras from 1957 and later, such as Hasselblad 500 series, 200 series, and SWC, to reintroduce classics and provide creative possibilities.

The CFV 100C digital back and 907X camera body form a medium format digital camera. With the compact design and a large 100-megapixel back-side illuminated (BSI) CMOS sensor, the camera boasts 16-bit colour depth and a dynamic range of 15 stops. Hasselblad Natural Colour Solution (HNCS) technology is integrated into the camera's system, delivering superb, true-to-life colours that match what the human eye sees. A vast range of high-quality lenses including XCD, HC, HCD, XPan, and V System are supported.<sup>[1]</sup>

## 1.2 FEATURE HIGHLIGHTS

### Powerful Compatibility

#### 907X Camera Body

When using the CFV 100C with the 907X camera body, all XCD System lenses are supported. All HC/HCD, XPan, and V System lenses can be used with the corresponding lens adaptor.



- Only certain functions of the camera are available when using an H System lens.
- Only electronic shutter mode is available when using a V System lens or XPan System lens with the 907X camera body.

#### Hasselblad V System Film Cameras

The CFV 100C supports integration with the Hasselblad V System's 500 Series, 200 Series, and other classic film cameras. This integration allows these film camera bodies to capture digital imagery.

#### Technical Cameras

The CFV 100C can be paired with technical cameras to capture images of elevated precision.



- When the CFV 100C is used with V System cameras and technical cameras, it only supports manual focus.

[1] Relevant system adaptor is required to use HC, HCD, XPan, and V System lenses.

## 100-Megapixel Medium Format BSI CMOS Sensor

Utilising a 100-megapixel medium format BSI CMOS sensor with a native ISO of 64, the CFV 100C captures life in vivid colour and exquisite detail. Over 281 trillion colours are represented with the 16-bit colour depth. This immense dimension of colour paired with 15 stops of dynamic range allows the CFV 100C to capture the subtle intricacies of highlights and shadows as they are seen in the natural world.

## HNCS

The HNCS optimises colours to appear as authentically as the eye perceives them. Images are captured without any preset.

## Phase Detection Autofocus

The CFV 100C utilises Phase Detection Autofocus (PDAF) for fast focusing. 294 PDAF zones spread over the 100-megapixel sensor surface provide swift and accurate focusing at the press of a button.

## Built-in 1TB SSD

The camera offers ample storage with a built-in 1TB SSD for high-volume and high-speed storage. Additional space can be added using the CFexpress Type B card slot.

## Tilting Touch Display

The 3.2-inch touch display presents a clear image even under intense light and tilts to gradual angles for diverse shooting needs. It supports a resolution of 2.36 million dots, bringing accurate, true-to-life colours to view. The Hasselblad User Interface (HUI) is neat and optimised. Featuring intuitive touch control, simply slide and tap to access the most used operations.

## Phocus Mobile 2 and Phocus

The built-in Wi-Fi connectivity allows users to create a portable photography workflow with wireless shooting and export and edit images using Phocus Mobile 2<sup>[1]</sup> on an iPhone or iPad. Full tethered operations include high-speed tethered shooting, and real-time RAW image processing is available using the Mac or Windows version of the Phocus software.<sup>[1]</sup> Both the Phocus Mobile 2 app and Phocus software use HNCS to deliver correct colours.

[1] Phocus Mobile 2 is compatible with iPad models and iPhone Xs or above with more than 3GB of RAM running on iOS 15.0 or later. Phocus is compatible with computers with 8GB of RAM or more running on macOS 10.15 or later, or Windows 7 64-bit or later. Visit the official Hasselblad website for more information.

## High-Speed Transmission

The camera has a USB-C 3.1 Gen 2 port that supports a max 10Gbps transmission rate. PD 3.0 fast charging and third-party PD 3.0 chargers are supported, removing the need to carry multiple charging devices.

## 1.3 907X & CFV 100C SPECIFICATIONS

### CFV 100C Digital Back

Camera Type	Medium format digital back with autofocus, auto-exposure
Construction	Machined aluminium
Sensor Type	Back-side illuminated (BSI) CMOS, 100 megapixels (11656 × 8742 pixels, pixel size 3.76µm)
Sensor Dimensions	43.8 × 32.9mm
IR Filter	Mounted in front of sensor
Operating Temperature <sup>[1]</sup>	-10° to 45° C (14° to 113° F)
Operating Humidity	No more than 85% without condensation
Supported Cameras	907X camera body, most of Hasselblad V System cameras built from 1957 onwards (SWC excluded)
Supported Lenses	Hasselblad XCD Lenses; all HC/HCD, XPan, and V System Lenses using the corresponding lens adaptor
Lens Equivalent Focal Length	Multiplier for full-frame lens equivalent focal length is 0.78
Dimensions	91 × 92 × 61mm
Weight (battery and memory card excl.)	460g
<b>Image and Storage</b>	
File Format	Hasselblad 3FR RAW, full size JPG and HEIF
Image Size	3FR RAW: 206MB on average JPG: 40MB on average HEIF: 20MB on average
Colour Definition	16-bit; dynamic range up to 15 stops
Colour Depth	Hasselblad 3FR RAW can be set to 14-bit or 16-bit HEIF: 10-bit
Colour Management	HNCS
Capture Rate	Up to 3.3fps in a 14-bit colour depth
Storage Options	Built-in 1TB SSD. Extra CFexpress Type B card with a max storage capacity of 512GB supported
Recommended Memory Cards	Sony CEB-G series CFexpress Type B memory cards (128GB) SanDisk Extreme Pro CFexpress Type B memory cards (128GB, 256GB, 512GB)

<b>Interface</b>	
Host Connection Type	USB 3.1 Gen2 Type-C connector (transfer speed up to 10Gbit/s)
Expansion Connection	Hot shoe contacts
Extra Ports	Shutter control port, flash sync input, flash sync output, ELX output
<b>Shutter</b>	
Shutter Modes	Mechanical shutter, electronic shutter
Shutter Type	Electronically controlled leaf shutter
Shutter Speed	68 min to 1/4000s with XCD Lenses. <sup>[2]</sup> Up to 1/800s or 1/2000s with HC/HCD Lenses. Electronic shutter 68 min to 1/6000s
<b>Exposure Control</b>	
ISO Speed Range	ISO Auto, 64, 100, 200, 400, 800, 1600, 3200, 6400, 12800, 25600
Exposure Metering	Spot, centre weighted, and centre spot
Exposure Modes	P/A/S/M/AUTO
Metering Range	Minimum -3 EV
Exposure Compensation	Manually adjusted between -5 to 5 EV with a step of 1/2 or 1/3
<b>Capture and Focusing</b>	
Drive Modes	Single Drive, Continuous Drive, Self-Timer, Interval Timer, Exposure Bracketing, Focus Bracketing
Autofocusing Type	PDAF and CDAF
PDAF Zones	294
Autofocusing Method	AF-S (single), face detection supported
Touch	Touch AF and Move AF Point supported
Manual Focus	Focus Indicator, Zoom In, and Focus Peaking supported
<b>Display</b>	
Screen Type	Touch display including click, drag, and pinch/spread to zoom
Display Specifications	3.2-inch TFT type, 24-bit full-colour, 2.36-million-dot (1024×768)
Tilting Angle	40°, 90°
Histogram Feedback	Supported in Live View and Browse modes
<b>Power Supply</b>	
Battery Type	Rechargeable Li-ion battery (7.27V DC/3400mAh)



<b>Charging Method</b>	Connect the USB-C port on the camera to an external power supply
<b>Charging Time</b>	Approximately two hours to fully charge the battery using the included 30W USB-C charger and USB-C to USB-C cable
<b>Charging Temperature</b>	5° to 40° C (41° to 104° F)
<b>Endurance</b>	420 images as measured under conditions specified by CIPA
<b>Software</b>	
<b>Phocus Mobile 2</b>	Phocus Mobile 2 is compatible with iPad models and iPhone Xs or above with more than 3GB of RAM running on iOS 15.0 or later
<b>Phocus for Mac/PC</b>	Phocus is compatible with computers with 8GB of RAM or more running on macOS 10.15 or later, or Windows 7 64-bit or later
<b>Flash</b>	
<b>Flash Sync Speed</b>	Flash can be used at all shutter speeds. Mechanical shutter only
<b>Flash Control</b>	ISO 64 to 25600 Output adjustable from -3 to +3 EV
<b>Flash Compatibility</b>	In TTL-mode, the following Flash products can be used: Nikon Flash: SB-300, SB-500, SB-700, SB-5000 Profoto Flash: A10, A1, air remotes: Connect Pro, Connect, Air Remote TTL

## 907X Camera Body

<b>Construction</b>	Machined aluminium
<b>Weight</b>	160g
<b>Dimensions</b>	102 × 91 × 28mm
<b>Connection Type</b>	Control Grip Contacts
<b>Operating Temperature</b>	-10° to 45° C (14° to 113° F)
<b>Operating Humidity</b>	No more than 85% without condensation

---

## 907X & CFV 100C

---

Weight (battery and memory card excl.)	620g
Dimensions	102 × 92 × 84mm

---

[1] When the camera is in a high temperature environment, the internal temperature of the camera may exceed 45° C due to the heat generated on its own during operation. This will trigger the overheating alarm and automatic shutdown.

[2] The fastest shutter speed varies depending on the lens in use. Refer to the datasheet of the corresponding lens.

## 1.4 CHARGING

The digital back comes with the battery already inserted in the battery slot. Remove the protective film on the battery and fully charge before using for the first time.

### How to Charge

- Slide the battery cover on the side of the digital back toward the touch display to open (1). Push the battery release lever down (2) to release the battery, and then remove it. Remove the protective film (3). Insert the battery into the digital back until the battery is firmly secured (4).

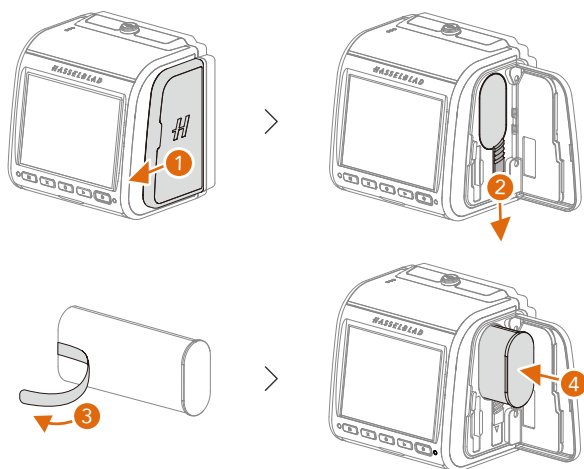

- After the battery is inserted into the digital back, the status LED on the digital back will display the current battery level. Refer to the table below.

Blinking Pattern		Battery Level
x1	Blinks yellow once	0-25%
x2	Blinks yellow twice	26-50%
x3	Blinks yellow three times	51-75%
x4	Blinks yellow four times	76-95%
—	Solid yellow	96-100%

2. Connect the USB-C port of the camera with the provided 30W USB-C charger using the USB-C to USB-C cable and connect the charger to a power outlet (100-220V, 50-60Hz).

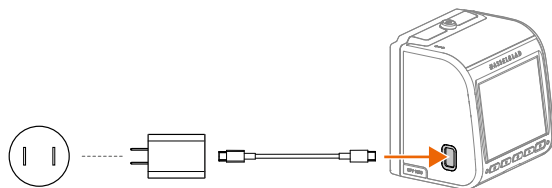

It takes approximately two hours to fully charge the battery using the provided charger.



- It is recommended to use the provided charger or the Hasselblad Battery Charging Hub (not included) to charge the battery. Otherwise, use an FCC or CE certified USB PD charger.





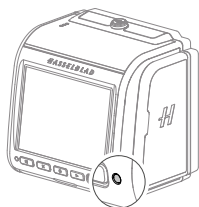

- DO NOT put batteries in a microwave oven or a pressurized container.
- DO NOT charge the battery near flammable materials or on flammable surfaces (e.g., carpet or wood).
- Disconnect the charger when not in use. Examine the charger regularly for damage to the cord, plug, enclosure, or other parts. Never use a damaged charger.
- Remove the battery from the camera if you intend to store the camera for an extended period. Discharge the battery to a power level between 30% and 60% and place the battery at room temperature. The battery power level can be checked through the rear touch screen of the camera.
- Fully charge and discharge the battery at least once every three months to maintain battery health.

## Charging Indicators

When charging the digital back with its power off, the status LED on the digital back will blink to display the current charging status. Refer to the table below.



Blinking Pattern		Battery Level
 x1 .....	Blinks yellow once	0-25%
 x2 .....	Blinks yellow twice	26-50%
 x3.....	Blinks yellow three times	51-75%
 x4 .....	Blinks yellow four times	76-100%

## 1.5 INSERTING THE MEMORY CARD

The CFV 100C digital back is equipped with a built-in 1TB SSD. Users can expand the capacity further with a CFexpress Type B memory card. Refer to the Memory Card section for more information about memory card instructions.

1. Slide the battery cover on the side of the digital back toward the touch display to open.
2. Insert the memory card into the card slot gently. Pay attention to the direction of the memory card when inserting. If the card cannot be inserted properly, make sure it is facing the correct direction. DO NOT insert by force.
3. Close the battery cover by pressing it down and sliding it in place.

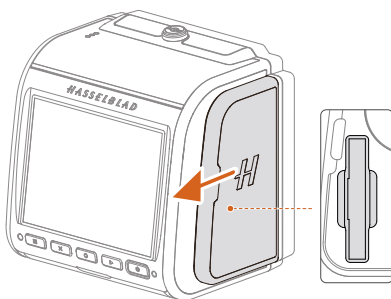

- To remove the memory card, open the battery cover, press the memory card to release it, remove it, and close the battery cover.
- After continuously using the camera, the surrounding area of the memory card slot will heat up. Avoid inserting or removing the CFexpress Type B memory card immediately after use to prevent the risk of burns.

## 1.6 USING CFV 100C WITH 907X

### Mounting CFV 100C and 907X

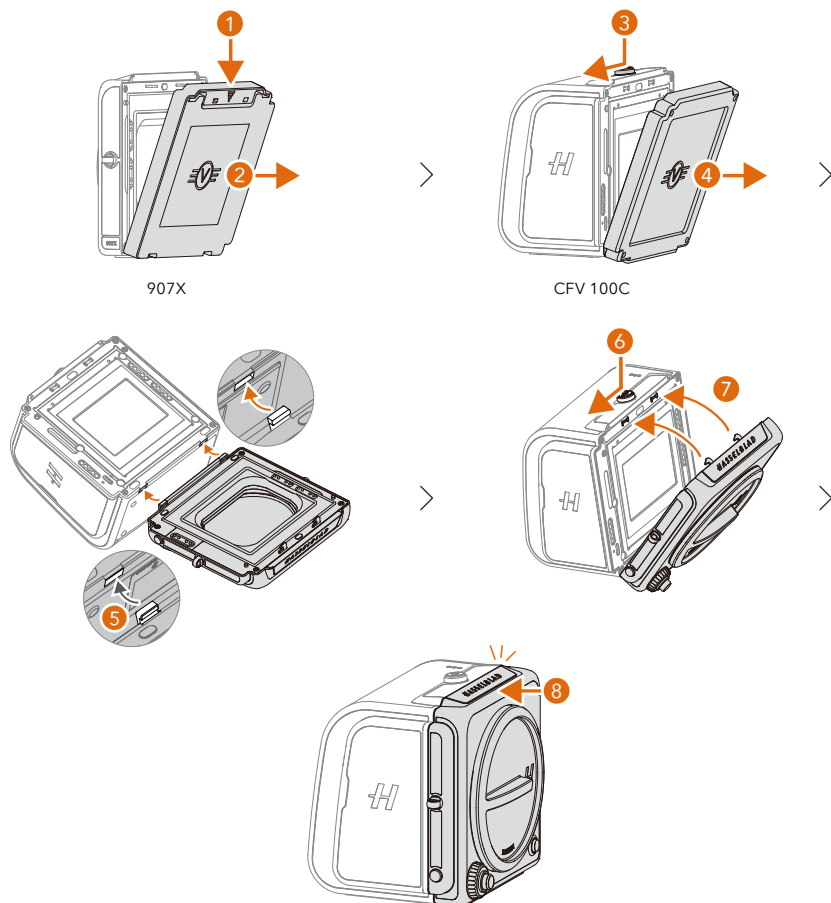

1. Remove the rear protective cover of the 907X camera body by pressing on the top of the cover (1) and then swinging it backwards (2).
2. Press and hold the lock button on the top of the digital back and push it in the direction as shown in the figure (3) and remove the protective cover (4).
3. Attach the lower supports on the 907X to the slots on the bottom of the digital back (5).
4. Press and hold the lock button, and then push it in the direction as shown in the figure (6), while mounting the 907X to the digital back completely (7). A click indicates that the two devices are securely attached (8).

## Mounting the Lens

The following section takes the CFV 100C used with 907X camera body and XCD lens as an example. A lens adaptor is required when using other lenses.

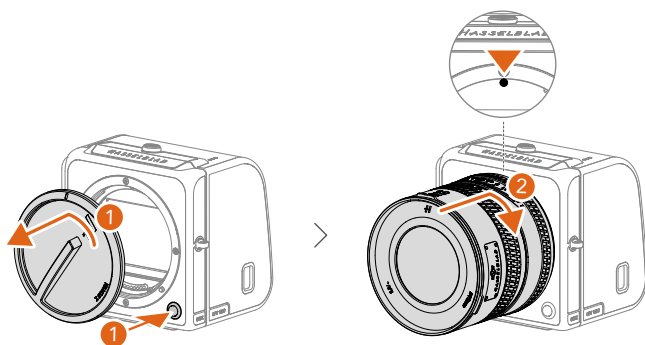

1. Press the lens removal button while turning the protective cover to remove the protection cover from the camera body.
2. Remove the lens caps and align the red dot on the lens with the red dot on the lens mount of the camera body. Attach the lens to the camera body and turn the lens clockwise until it clicks into place.
3. Make sure that the lens is firmly secured to the camera body before use or movement.



- To remove the lens, press the lens removal button while rotating the lens counterclockwise. Attach the lens protection caps on the detached lens to prevent damage.



- Be careful when attaching or removing the lens to prevent damage to the metal terminals on the camera or lens.
- DO NOT insert fingers or any other objects into the camera body. This can cause damage to the equipment.
- Attach the protective cover to the camera body after removing the lens.

## 1.7 USING CFV 100C WITH OTHER CAMERAS

When using the CFV 100C (hereinafter referred to as CFV) with other cameras, the control method and connection vary depending on whether the mechanical shutter or electronic shutter is used.

### Mechanical Shutter

Control Method	Camera Model	Remark
Phocus Remote Control	503CW/503CWD/503CXi + Winder CW	Exposure Cable 503CW is required for Phocus remote control of 503CW + Winder CW
	500EL, 500EL/M 500ELX, 553ELX	Exposure Cable EL is required for Phocus remote control of EL or EL/M
	555 ELD	/
Cable-Free Operation	500C, 500C/M 501 C, 501CM 503CX, 503CXi, 503CW, 503CWD	/
	SWC/M 903 SWC 905 SWC	/
	Modified 202FA, 203FE, 205TCC, 205FCC	With F type lenses and C/CF/CFi/CFE lenses in F or C mode (not the 202FA) setting
	2000FC, 2000FC/M, 2000FCW, 2003FCW, 201F Unmodified 202FA, 203FE, 205TCC, 205FCC	With F type lenses and C/CF/CFi/CFE lenses in F or C mode (not the 202FA) setting
	500EL, 500EL/M 500ELX, 553ELX 555ELD	/
Flash Sync Input Cable Required	FlexBody	/
	ArcBody	Shift settings are not recommended on cameras with wide-angle lenses and a short lens to image plane distance
	Any view camera with the Hasselblad V System adaptor	



## Electronic Shutter

When using the electronic shutter on the CFV, any camera with a V System mechanical interface can be used. As no mechanical shutter is required, any lens that fits the camera can be used.

Make sure that both the camera and lens are set to open mode before capture.

## Mounting CFV 100C and Camera



1. Press and hold the lock button on the top of the digital back and push it to the direction as shown in the figure (1) and remove the protective cover (2).
2. Mount the camera to the digital back.



- Users can use the hot shoe adaptor and flash sync input cable to connect the flash to the camera. The focusing screen mask can also be used.
- Watch the tutorial videos on the official Hasselblad website for more information.

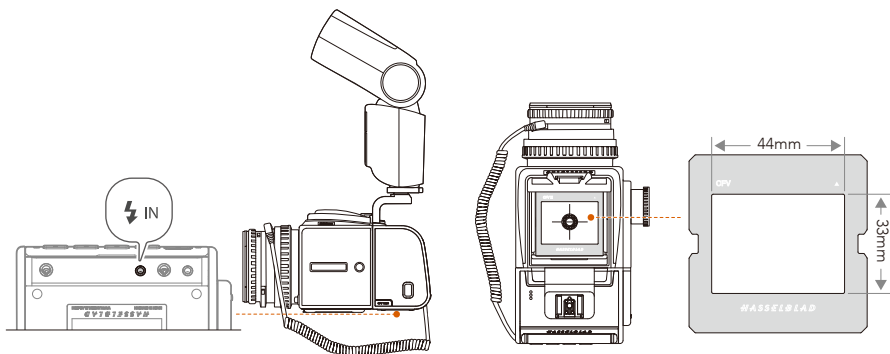

## Using CFV with 500 Camera

Select 500 in Camera Body Settings in Main Menu when using the following camera models.

- 500C
- 500C/M
- 501C
- 501CM
- 503CX
- 503CXi
- 503CW
- 503CWD



- Users can release the camera even if the CFV is not ready for a capture. Make sure the status LED on the CFV is green before releasing the camera.

### Start Live View with 500C or 500C/M Camera

1. Set B mode on the lens.
2. On the 500C or 500C/M camera, there is a small lever (time catch) **(A)**. Switch the lever from 0 to T position **(B)**.
3. Activate Live View from Control Screen (LV).
4. Press the shutter release.
5. Press the menu button or browse button to end Live View.
6. Move the time catch back to the 0 position, and the shutter will close.

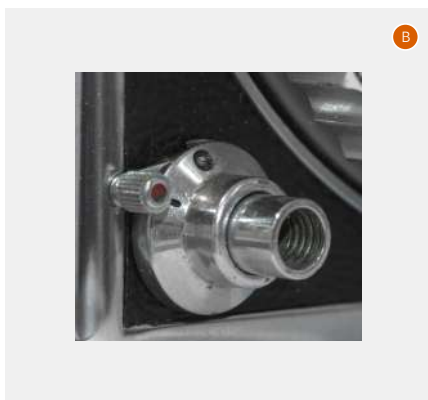
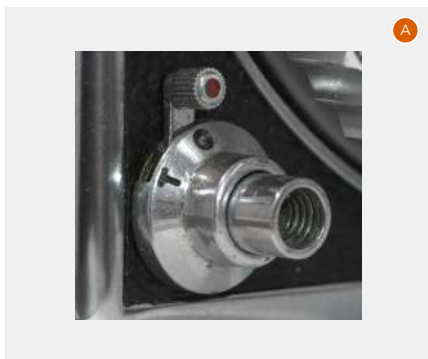

## Start Live View with 501 or 503 Camera

1. Set B mode on the lens.
2. Use a lockable cable release and set it to lock mode **(C)**.
3. Activate Live View from Control Screen (LV).
4. Release the camera with the cable release.
5. Press the menu button or browse button to end Live View.
6. Open the cable release lock.



- When using the Winder CW on the 503CW, the release button must be kept pressed down to keep the camera open.

## Remote Control of 503CW with Winder CW

When the 503CXi or 503CW camera is equipped with the Winder CW, it can be remotely released when tethered to a Mac or PC running Phocus.

Connect the CFV and the socket at the bottom of the Winder CW using the exposure cable 503 **(A)**. The 2.5mm connector shall be connected from the ELX socket on the CFV **(B)**.

When the camera is connected via USB to a computer running Phocus, users can release the camera from the computer. Refer to the Phocus User Guide for more details.



- To use Live View, make sure to open the camera manually. Then Live View can be started either from the CFV Control Screen or from Phocus.

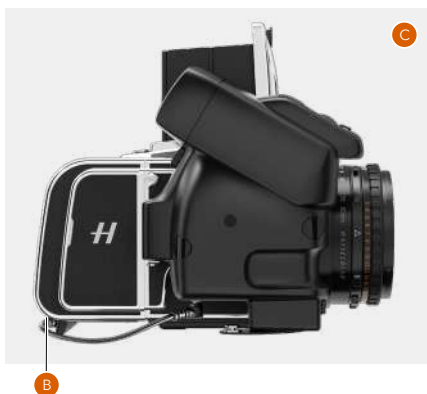
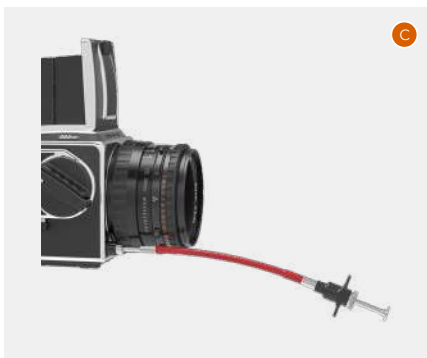

## Using CFV with 200 or 2000 Camera

A small modification to the previous generations of the camera is required when using with the CFV. A modified 200 camera should use the 200 Modified setting. An unmodified 200 camera must use the 200 setting. A 2000 camera requires the 2000 setting.



- A camera that has been modified is identified by a label on its left side as shown in **(A)**.
- The camera cannot read the ISO value set on the CFV. If using any automatic mode on the camera, set the corresponding ISO value also on the camera.
- Users can release the camera even if the CFV is not ready for a capture. Make sure the status LED on the CFV is green before releasing the camera.

### Start live view

1. Set B mode on the lens. If using an F type lens, no special setting is required.
2. Use a lockable cable release and set it to lock mode **(B)**.
3. Activate Live View from Control Screen (LV).
4. Release the camera with the cable release.
5. Press the menu button or browse button to end Live View.
6. Open the cable release lock.

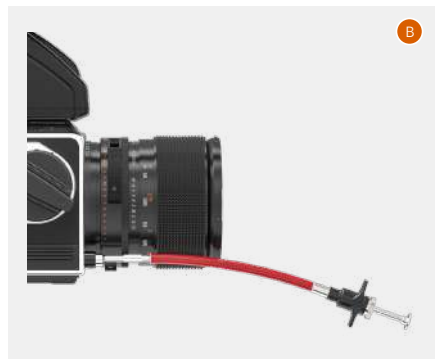

## Using CFV with SWC Camera

Select SWC in Camera Body Settings in Main Menu when using the following camera models.

- SWC/M
- 903 SWC
- 905 SWC



- Old versions of SWC cameras are not supported.
- Make sure the status LED on the CFV is green before releasing the camera.
- When releasing the camera, press firmly on the shutter release button. Pressing too slowly or stopping halfway can result in black images.

### Start live view with a SWC camera

1. Set B mode on the lens.
2. On the SWC camera, there is a small lever (time catch) **(A)**. Switch the lever from 0 to T position **(B)**.
3. Activate Live View from Control Screen (LV).
4. Press the shutter release.
5. Press the menu button or browse button to end Live View.
6. Move the time catch back to 0 position, and the shutter will close.

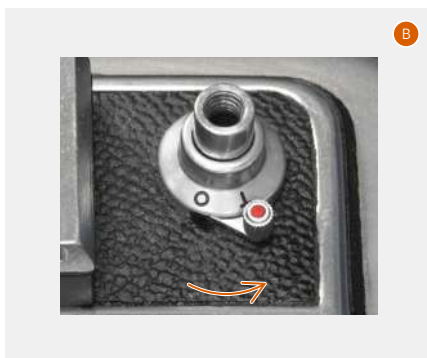
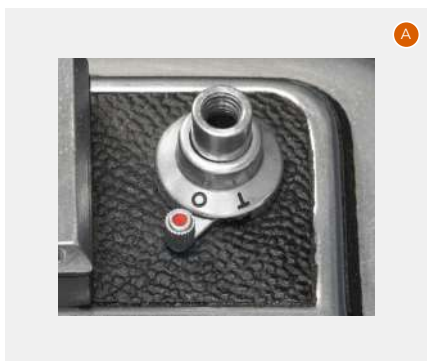

## Using CFV with EL Camera

Select ELX in Camera Body Settings in Main Menu when using the following camera models.

- EL
- EL/M
- ELX



- Users can release the camera even if the CFV is not ready for a capture. Make sure the status LED on the CFV is green before releasing the camera.

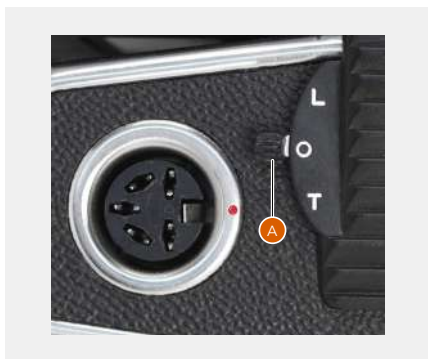

## Start Live View with EL Camera

1. Set B mode on the lens.
2. Activate Live View from Control Screen (LV).
3. On the EL camera, there is a small lever (time catch) **(A)**. Switch the lever from 0 to T position **(B)**.
4. Press the menu button or browse button to end Live View.
5. Move the time catch back to 0 position, and the shutter will close.

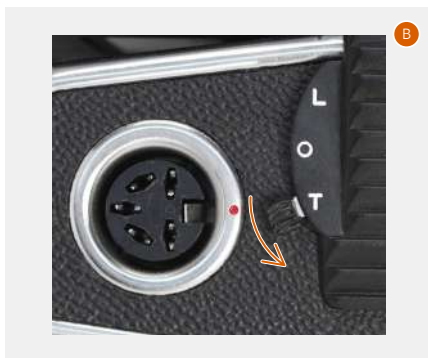

## Remote Control of EL Camera

Connect the CFV and the socket at the bottom right of the Winder EL camera **(C)** using the exposure cable EL **(A)**.

The 2.5mm connector shall be connected from the ELX socket on the CFV **(B)**.

When the camera is connected via USB to a computer running Phocus, users can release the camera from the computer. Refer to the Phocus User Guide for more details.

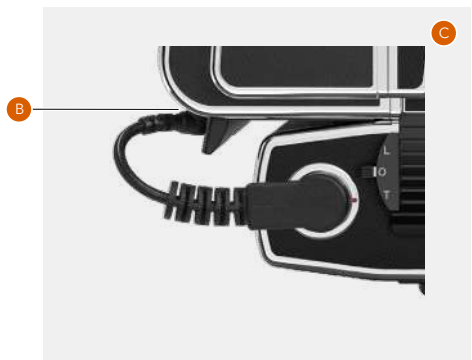

## Using CFV with ELD Camera

Select ELD in the Camera Body Settings in Main Menu.

This ELD option is for the 555ELD camera only. This model has the following extra dedicated features for the CFV:

- Cable-free remote control from Phocus.
- Exposure will be locked if the CFV is not ready to make a capture.



- When using the CFV on the ELD camera, the release button should be placed in the DIG input **(C)**. This will allow the CFV to lock the exposure if it is not ready for a capture.

### Start Live View with ELD Camera

1. Set B mode on the lens.
2. Activate Live View from Control Screen (LV).
3. On the ELD camera, there is a small lever (time catch) **(A)**. Switch the lever from 0 to T position **(B)**.
4. Press the menu button or browse button to end Live View.
5. Move the time catch back to 0 position, and the shutter will close.

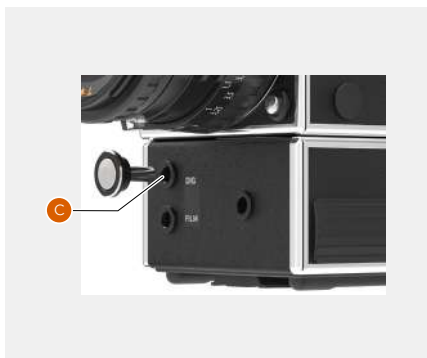
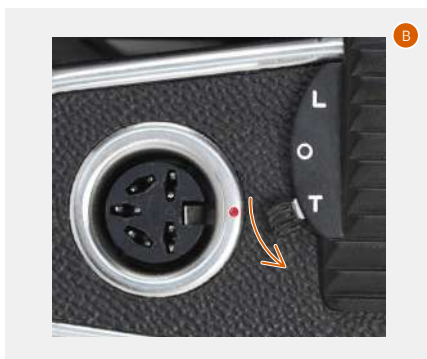
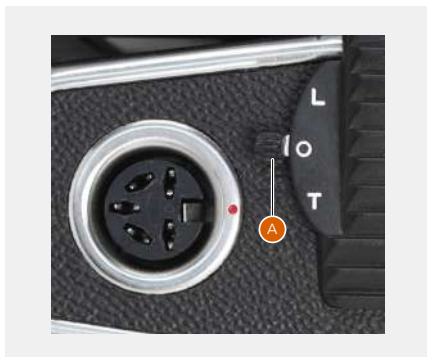



## Using CFV with Flash Sync on Camera

The Any (Flash Sync) setting in the Camera Body Settings is for cameras which have a flash sync socket and are not listed in the camera body list. Examples of such cameras are technical cameras/view cameras **(A)** and ArcBody camera **(B)**.

Connect the flash sync input cable **(C)** from the sync socket of the lens **(D)** to the flash sync input of the CFV **(E)**.

### Start Live View

1. Make sure that the lens is open.  
Details on how to do this depends on the actual lens.
2. Activate Live View from Control Screen (LV).
3. Press the menu button or browse button to end Live View.

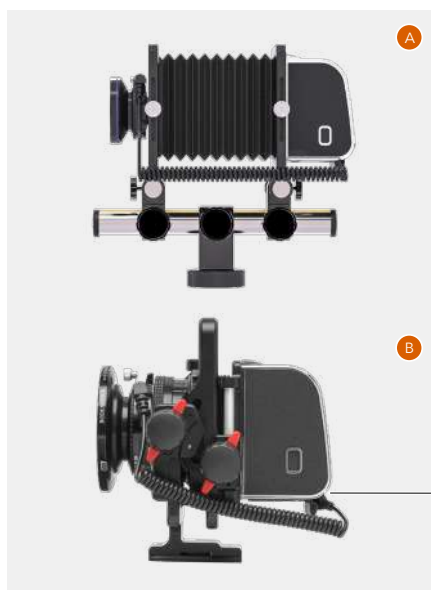

## Using Camera with Electronic Shutter

When the camera body is set to Any (Electronic Shutter) in the settings, the electronic shutter of the sensor is used. This is for use with lenses or cameras without a shutter.

Refer to the Live View section and Control Screen section for more details about the usage of the electronic shutter. See the available settings for the electronic shutter in the Settings section.

## Using with Flash

The flash can be used with most combination of CFV and camera body.



- The flash is not supported when the camera body is set to Any (Electronic Shutter) in the settings.
- For studio use where using a desktop computer and a flash system connected to the mains outlet, make sure that both the computer and flash are connected to mains outlets with a common ground.
- Users can also use the remote flash trigger to electrically separate the flash from the camera and computer.

### Using 500 Camera

The flash sync cable can be connected directly to the sync socket of the lens **(A)**.



### Using Modified 200 Camera with C Type Lens

When using a C type lens in the C shutter mode, connect the flash sync cable to the sync socket of the lens **(B)**.

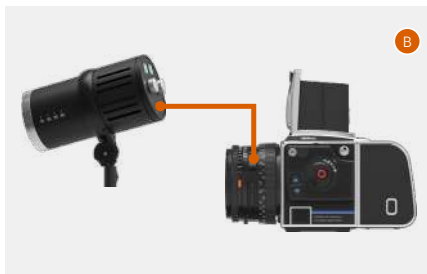

### Using Modified 200 Camera with F Type Lens

When using a C type lens or F type lens in the F shutter mode, connect the flash sync cable to the sync socket of the camera **(C)**.



### Using Cameras with Any (Flash Sync) Setting

When using the Any (Flash Sync) setting, for example, with a technical camera, connect the flash sync input cable from the sync socket of the lens to the flash sync input of the CFV **(1)**. Then connect the flash sync output cable from the flash sync output **(2)** to the flash.



## 1.8 MOUNTING THE HOT SHOE ADAPTOR

The flash can be connected after mounting the hot shoe adaptor to the digital back.

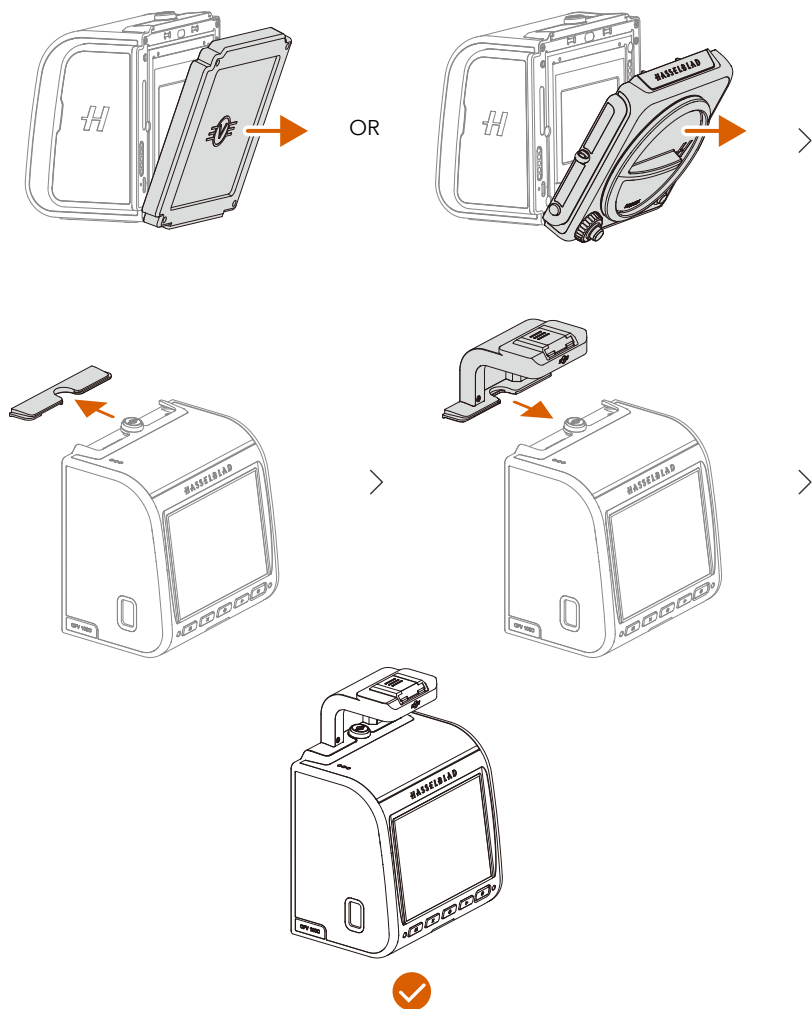

1. Detach the digital back from the connected device.
2. Remove the top cover of the digital back and insert the hot shoe adaptor into the hot shoe adaptor port.

## 2 FUNCTIONS

## 2.1 OVERVIEW

### CFV 100C Digital Back

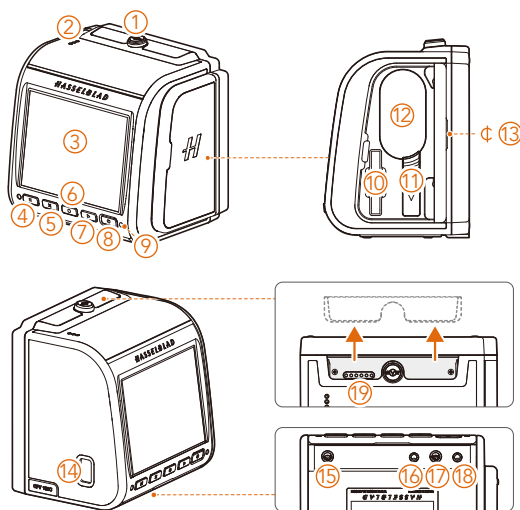

#### 1. Lock Button

To detach the protective cover or the camera connected to the digital back, press and hold the lock button and then push the button to the right when facing the touch display.

#### 2. Speaker

#### 3. Tilting Touch Display

The touch display is used to display information and control the camera. Its operations are similar to those on the touchscreen of a smartphone or a tablet. The touch display can be tilted up to 90° upwards. Lift the screen using the groove at the bottom of the display to tilt the display upwards. There are click-stops for 40° and 90°.

#### 4. Menu Button

In Live View, Main Menu, or Browse Mode, press to enter Control Screen.

On Control Screen, press to enter Main Menu.

In sub menus, press to return to Main Menu.

#### 5. Delete Button

The button has multiple functions that vary in different scenarios. In Browse Mode, press to delete the selected image.

## 6. Circle Button

The button has multiple functions that vary in different scenarios. In Live View or Browse Mode, press to show or hide parameter information.

## 7. Browse Button

## 8. ON/OFF Button





Press and hold for 1 second to power on the camera and the “H” logo will appear on the touch display.

After a few seconds (customisable) of inactivity, the camera will enter Standby Mode. Press the button once to enter or exit Standby Mode.

Press and hold the button to power off the camera completely when it is powered on (not in Standby Mode).

## 9. Status LED

Indicates the camera status after being powered on. Refer to the table below.

	— Solid green	The camera is ready to make a capture.
	..... Blinks green	The image is written to the memory card or built-in storage.
	— Solid yellow	The camera is busy or not ready to make a capture, such as when the camera is connecting to a computer as mass storage, when the lens is not mounted, or when the storage is full.
	— Solid red	Error state. Contact the Hasselblad authorised service centre.

## 10. CFexpress Card Slot

Insert a CFexpress Type B memory card to expand storage.

## 11. Battery Release Lever

Push the lever to release the battery and then remove the battery.

## 12. Battery

## 13. Focal Plane Mark

## 14. USB-C Port

For charging the battery and image transmission. USB 3.1 is supported. Connect the port to the provided charger using the USB-C to USB-C cable to charge the battery. Connect the port to a computer using a USB-C cable of USB 2.0 or above to read images stored in the camera or for Phocus.

## 15. Shutter Control Port

Connect the shutter control cable to the port to control the shutter for capture using external shutter control.

## 16. Flash Sync Input

For synchronization with mechanical shutters. Use the supplied flash sync input cable.

## 17. Flash Sync Output

For connection of external flashes. Use the official flash sync output cable for cable connected flashes. Wireless flash triggers with a 2.5mm plug can be connected using the exposure cable CW. Max allowed voltage: 100VDC.

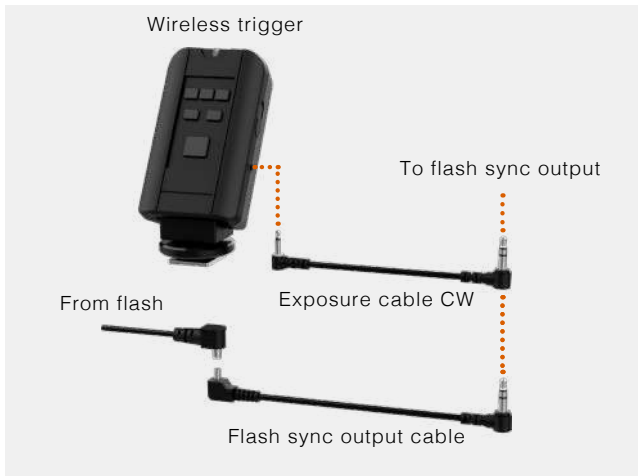

## 18. ELX Output

For connection to an EL camera or the Winder CW to enable exposure remote control from Phocus.

## 19. Hot Shoe Contacts

Mount the hot shoe adaptor to connect compatible devices such as a flash.

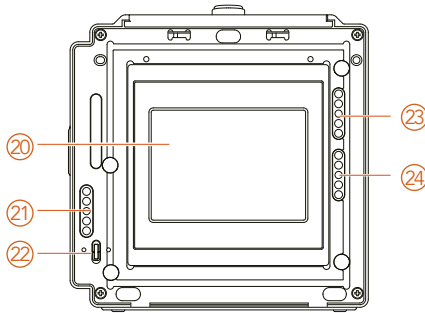

**20. Sensor**

Make sure to read the cleaning instructions in the Appendix.

**21. Contact for 200 Series cameras**

Electrical contact used with modified 200 Series cameras.

**22. Release bar sensor**

Used to synchronize exposure with the 500, EL and SWC type cameras.

**23. 907X Contact**

Contact used with the 907X camera body.

**24. 555 ELD Contact**

Contact used with the 555 ELD camera.

## 907X Camera Body

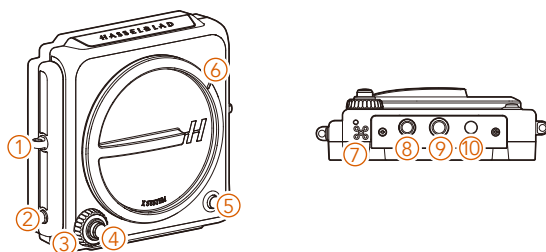

### 1. Strap Lugs

### 2. Function Button

The button has multiple functions that vary in different scenarios.

On Control Screen or in Live View, press and hold the button and then toggle the control dial to adjust exposure compensation.

On Control Screen or in settings menus, press to confirm a selected option.

During image preview, press the button to zoom in to 100%.

### 3. Control Dial

Toggle to adjust the aperture or shutter speed, switch between options for the camera settings, and switch images in preview.

### 4. Shutter Release Button

This button has two positions. Press half way to activate the camera from Standby Mode, or start auto-focusing and exposure metering. Press all the way down to release the shutter. The chosen exposure procedure, for example, Self-Timer, is also activated with this button.

### 5. Lens Removal Button

When the lens or protective cover is mounted, press and hold the button while rotating the lens or the cover to remove.

### 6. Protective Cover Index

When mounting the protective cover, align the index with the mark on the lens mount and rotate the cover.

### 7. Control Grip Contacts

Communicate with the control grip.

### 8. Control Grip Screw Hole

To mount the control grip.

### 9. Tripod Thread 1/4"

### 10. 5.2mm Blind Hole

## 2.2 TOUCH DISPLAY

The rear screen is a tilting touch display and is touch sensitive and easy to operate. Use it the same way as on a smartphone. For example, swipe to scroll, tap to select, or spread and pinch to zoom in or out of images or the focus point. Users can also navigate by using the buttons under the touch display.

The touch display has Live View, Control Screen, Main Menu, and Browse Mode. Users can take photos, view the camera status, set parameters, and browse files in different views. This section will introduce Live View, Control Screen, and Browse Mode displays. For Main Menu displays, refer to the Settings section.

### Touch Display Operations

#### Touch Controls

Action	Function
Tap/Press	Select and confirm.
Double Tap	Zoom in to 100%. Double tap again to zoom out to full view.
Spread (move two fingers apart)	Zoom in when browsing images.
Pinch (move two fingers close)	Zoom out when browsing images.
Swipe Left	Switch the image or move the image left when browsing images. On Control Screen, switch to Main Menu.
Swipe Right	Switch the image or move the image right when browsing images. In Main Menu, switch to Control Screen. In sub menus, return to the previous menu.

## Button and Scroll Wheel Controls

On Control Screen, Menu Screen, and in Browse Mode, use the buttons on the digital back or the button and dial on the 907X camera body for selection, confirmation, and back operations.

Camera Display	Buttons/Control Dial	Function
Control Screen Menu Screen	Circle Button	After an adjustable parameter is activated on the screen, press to enter the option list or to confirm a selected option. When the parameter option is a switch, press to switch between on and off.
	Delete Button	After an adjustable parameter is activated on the screen, press to cancel the selection or return to the previous menu.
	Function Button (907X)	Press to select adjustable parameters on the screen or to confirm the selected option.
	Control Dial (907X)	After an adjustable parameter is activated on the screen, toggle to switch between parameters and options.
Browse Mode	Delete Button	Delete the current image.
	Control Dial (907X)	Switch between captured images.
	Function Button + Control Dial (907X)	Toggle the dial counterclockwise to return to the parent view. For example, enter the 9 images view, select folders or storage to browse. Toggle clockwise to enter the subview. When viewing one image, toggle clockwise to zoom in on the image. When zooming in, toggle counterclockwise to zoom out.

## Screen Switch

Switch between different screens using the gestures below.

Between Live View/Browse Mode and Control Screen: Swipe down from the top and swipe up from the bottom.

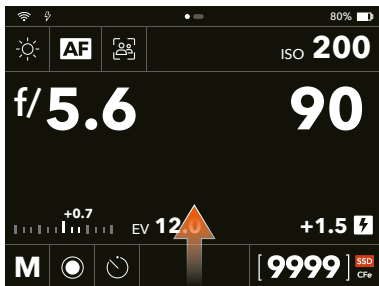
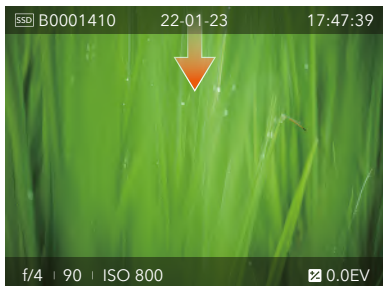
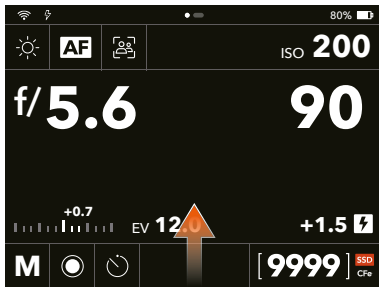

Between Control Screen and Main Menu: Swipe left and swipe right.

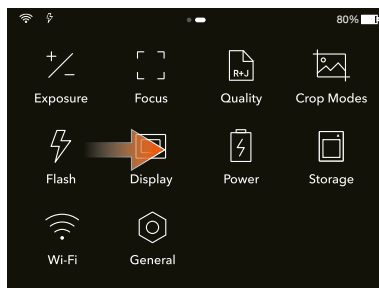
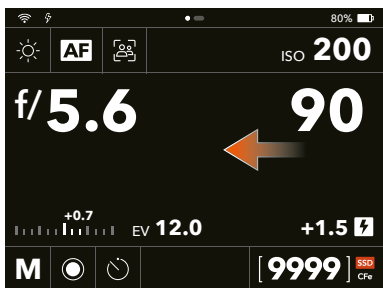

From Main Menu to Live View/Browse Mode: Swipe up from the bottom. If Live View or Browse Mode is displayed before entering Main Menu, the display will return to the corresponding view from Main Menu after swiping up from the bottom.

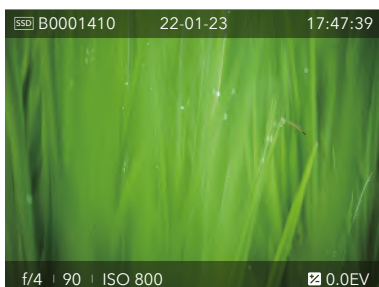
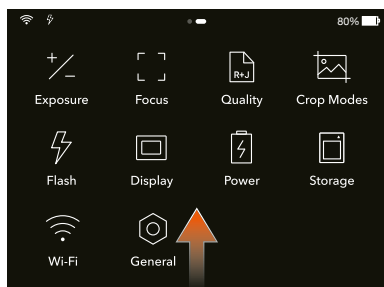
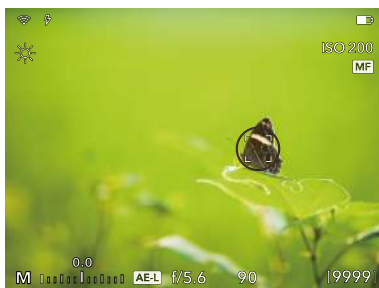
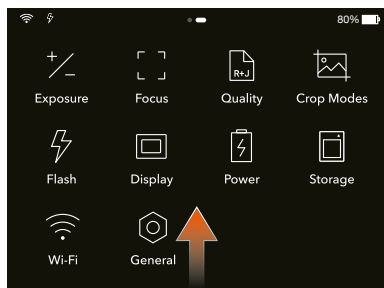

## Live View

In any screen, half-press the shutter release button to enter Live View. When using with cameras other than the 907X, tap **LV** on Control Screen to enter Live View.

Check the camera status and parameters, adjust some certain parameters, and take photos. Live View shows the exposure information by default. Press the circle button under the touch display to switch between different information display, including:

Exposure Information

Exposure Information + Histogram

Exposure Information + Grid

Exposure Information + Distance Scale

Exposure Information + Spirit Level

None (image and focus area only)

## Exposure Information Display

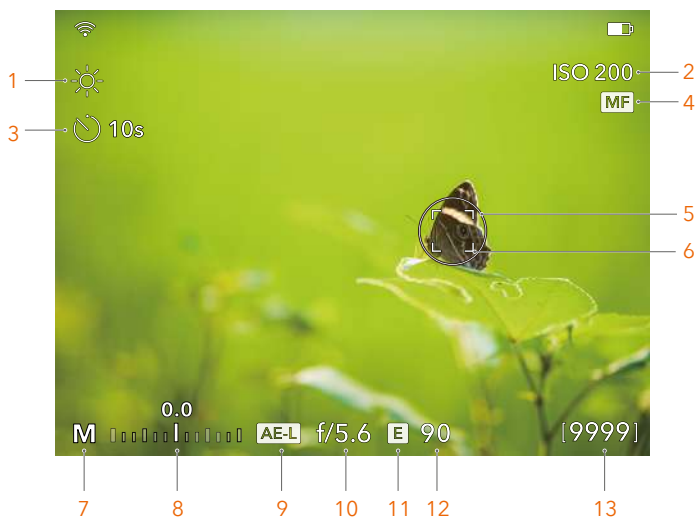

Using with the 907X camera body

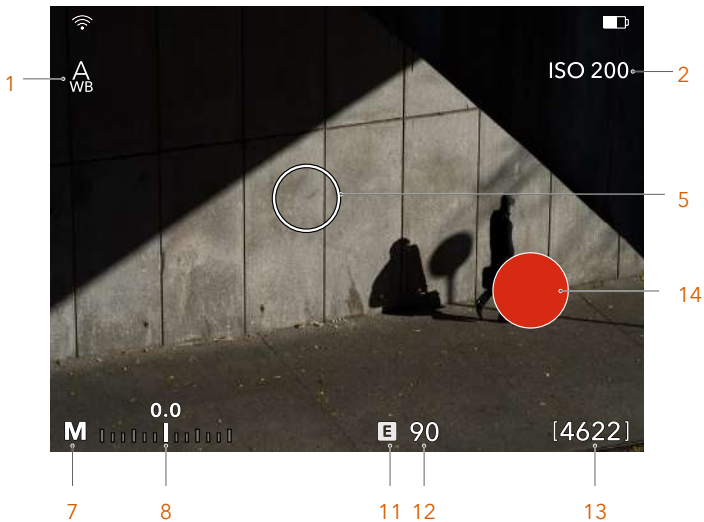

Using with other cameras and with the camera body set to Any (Electronic Shutter)

The screen display takes using with the 907X camera body as an example. When using with other cameras and with the camera body set to Any (Electronic Shutter), most of the screen elements (except for focus mode, drive mode, focus point, AE-L, and aperture) will be displayed. When the camera body is set to other options, only WB will be displayed.

Users can go to Control Screen to adjust the camera parameters displayed in Live View. Refer to the Control Screen section for more information.

### 1. White Balance (WB)

Tap the area to open the option list. Swipe on the touch display or toggle the control dial on the 907X camera body to select from the list. The settings are the same as WB on Control Screen. Refer to the Control Screen section for more information.

### 2. ISO

Tap to open the option list for ISO adjustment. Swipe on the touch display or toggle the control dial on the 907X camera body to select from the list.

### 3. Drive Mode

There is no icon displayed when Single or Continuous Drive mode is selected. When Self-Timer, Interval, Exposure Bracketing, or Focus Bracketing Drive mode is selected, the corresponding icon will appear. Refer to the Drive Modes section for more information on instructions for each mode.



#### 4. Focus Mode

The MF icon will be displayed when Manual Focus (MF) is selected. There is no icon displayed when Autofocus (AF) is selected and face detection is disabled. The icon for face detection will be displayed when Autofocus (AF) is selected and face detection is enabled. Refer to the Focus Modes section for more information on instructions for each mode.

#### 5. Metering Point

There will be a circle for spot metering when exposure metering is set to Spot Metering. Drag the circle to change the metering position. When using with the 907X camera body, the metering point and focus point will move together.

#### 6. Focus Point

When Move Focus Point is enabled in the settings, users can tap the touch display to adjust the position of the focus point, or spread or pinch on the screen to change the focus point size. In Manual Focus Mode, the focus indicator will be displayed when Focus Indicator is selected in the MF Assist settings. Refer to the Focus Modes section for more information.

#### 7. Exposure Mode

When using with cameras other than the 907X and with the camera body set to Any (Electronic Shutter), tap the icon to open the option list. The Manual and Aperture mode settings are the same as the exposure mode settings on Control Screen. Refer to the Control Screen section for more information.

#### 8. Exposure Scale

Automatic Exposure Mode (A/S/P) displays the current exposure compensation. Manual Exposure Mode displays the value of light metering.

#### 9. AE Lock (AE-L)

This icon will appear when AE lock is triggered.

#### 10. Aperture

#### 11. Electronic Shutter

This icon will appear when the electronic shutter is enabled in the settings.

#### 12. Shutter Speed

When using with cameras other than the 907X and with the camera body set to Any (Electronic Shutter), tap the shutter speed value to open the option list for shutter speed adjustment (in Manual Exposure mode) or to bring up the exposure adjustment scale (in Aperture Priority Automatic mode).

### 13. Remaining Frames

After powered on or switched to Live View from other screen, it will temporarily display the current setting for the image format, such as RAW, JPG, R+J, and then display the remaining frames.

A storage status icon will appear above the remaining frames when the camera is reading or writing data. The storage status of the memory card will also be displayed here. The descriptions of the icons are the same as those on Control Screen. Refer to the Control Screen section for more information.

### 14. Shutter Release Button

When using with cameras other than the 907X and with the camera body set to Any (Electronic Shutter), the shutter release button will appear. Tap to make a capture.

## Exposure Information + Histogram Overlay

Tap and hold the histogram window, and then drag to move its position.

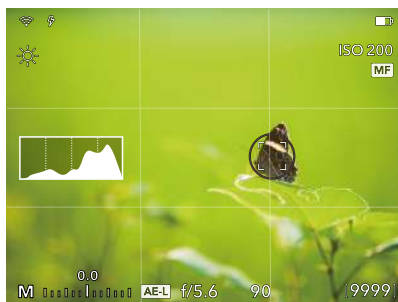

## Exposure Information + Grid Overlay

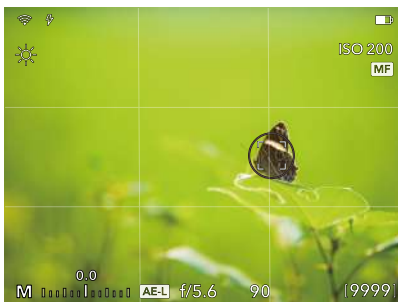

## Exposure Information + Distance Scale Overlay

The arrow of the distance scale will move to the corresponding value when adjusting the focus distance.

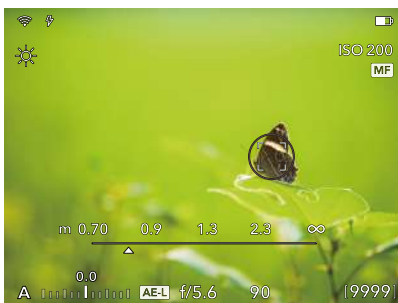

## Exposure Information + Spirit Level Overlay

Observe the tilt of the camera in the horizontal and vertical directions to help adjust the camera position. Tap the upper left corner to calibrate the spirit level. Refer to the Spirit Level Calibration section for more information.

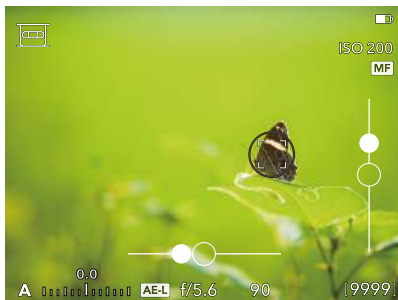

## Control Screen

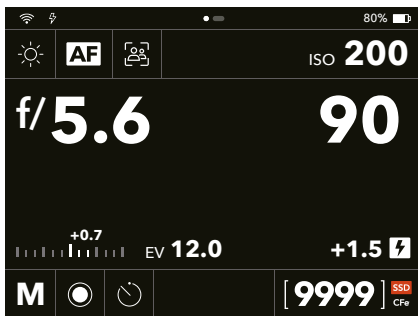

Using with the 907X camera body

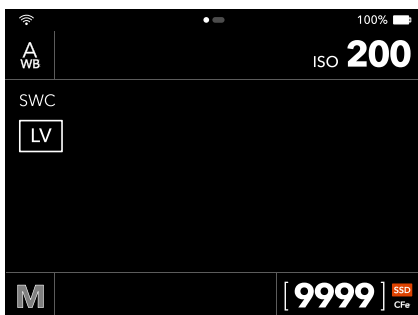

Using with other cameras



Using with other cameras and with the camera body set to Any (Electronic Shutter)

On Control Screen, view the current parameter settings and adjust. Tap the parameter requiring adjustment and change on Control Screen.

## Enter/Exit Control Screen

Swipe down from the top of the touch display or press the menu button on the right of the touch display to enter Control Screen.

Swipe left on the touch display or press the menu button to exit Control Screen and enter Main Menu.

When using with the 907X camera body, half-press the shutter release button to return to Live View.

When using with cameras other than the 907X, tap  on Control Screen to enter Live View.



- When Control Screen is displayed, there is no ongoing light metering. The sensor is inactive to save battery power.

## Locked Parameters on Control Screen

The following section takes the 907X camera body as an example to introduce the locked parameters on Control Screen in different exposure modes.

### A Mode

In Aperture Priority (A), users can change the aperture value and the shutter speed value will be automatic and displayed in grey.

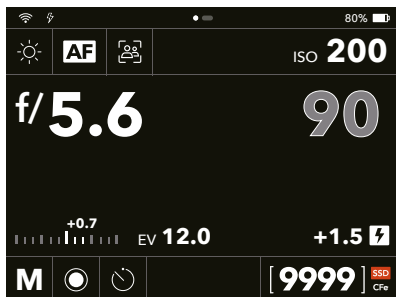

A Mode  
Shutter speed is automatic.

### S Mode

In Shutter Priority (S), users can change the shutter speed value and the aperture value will be automatic and displayed in grey.

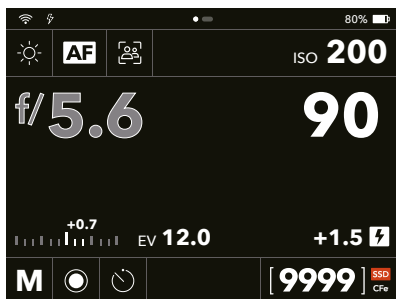

S Mode  
Aperture is automatic.

### P Mode

In P Mode, the aperture and shutter speed are automatic and displayed in grey indicating that users cannot change these settings. Use the control dial on the 907X camera body to shift aperture and shutter speed combination. Press and hold the function button on the 907X camera body and toggle the control dial for exposure compensation adjustment.

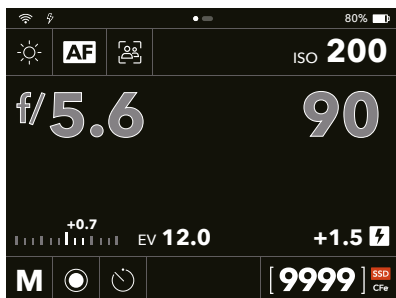

P Mode  
Aperture and shutter speed are automatic.

## Settings on Control Screen

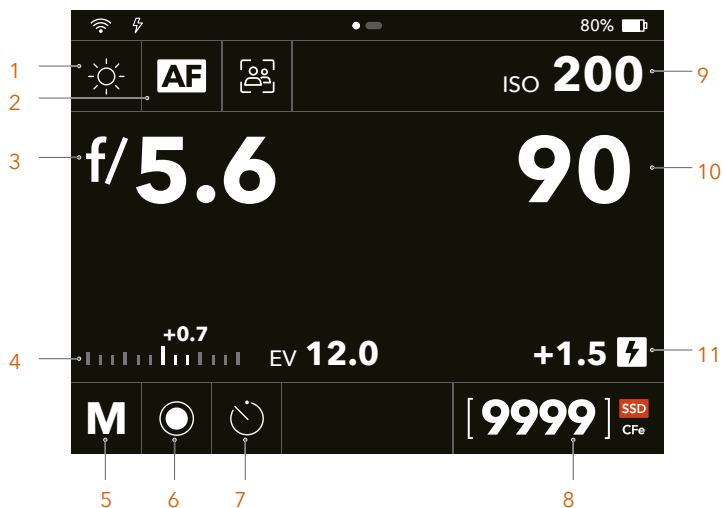

Using with the 907X camera body

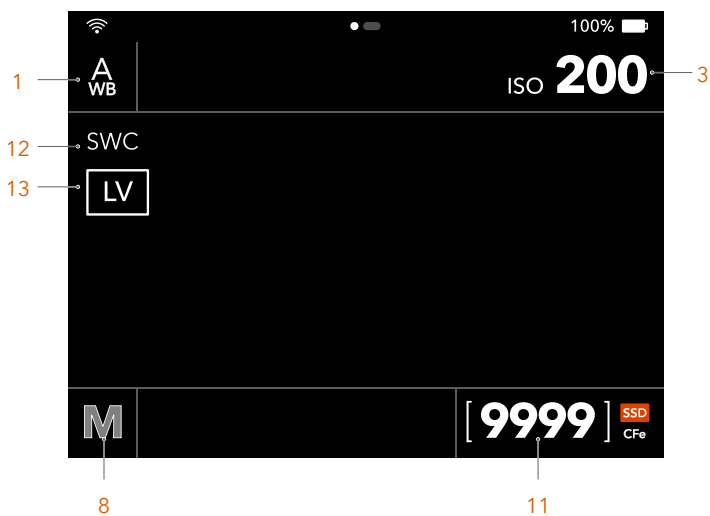

Using with other cameras

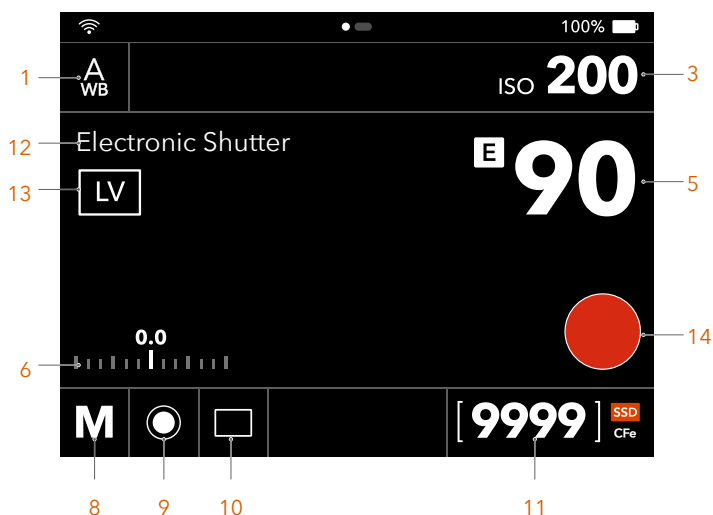

Using with other cameras and with the camera body set to Any (Electronic Shutter)

## 1. White Balance (WB)

Tap to enter the white balance mode list to select auto WB, preset WB, or manual WB. The colour temperature and tint values for each preset WB mode is shown in the table below.

If the preset modes cannot meet the requirements in some scenarios, users can adjust the temperature and tint values in the list on the right. In this case, the Manual WB Mode is automatically selected, and the adjustment will not affect the values in the preset WB modes.

	Temp [°K]	Tint
Cloudy	6500	10
Shade	7500	10
Daylight	5500	10
Tungsten	2850	0
Fluorescent	3800	21
Flash	5500	0
Manual	Variable 2000 to 10000	Variable -100 to 100





- When working with a flash in situations where the subject is lit with different colour temperatures, it is recommended to set the camera to Auto WB.

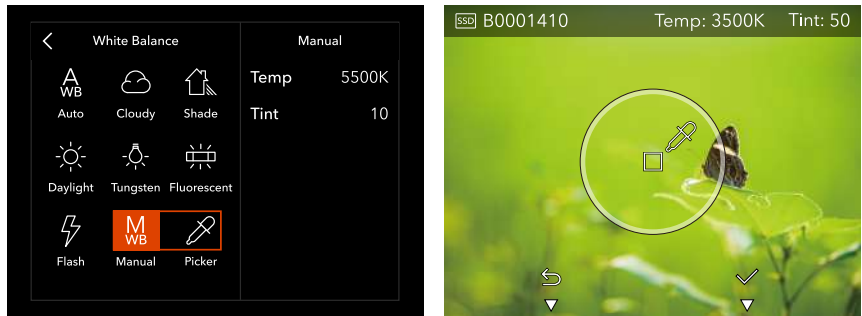

## Picker

Use the picker in the white balance mode list to pick the colour temperature and tint from a captured RAW image.



- a. Tap the picker icon  in the white balance mode list.
  - b. The screen will show the last captured image with a white balance picker tool. The status bar on top will show the colour temperature and tint of the current metering area. Swipe on the touch display outside the circle of the picker tool to switch between images.
  - c. Inside the circle of the picker tool is the area for moving the tool and the square in the middle is the metering area to calculate the colour temperature and tint values. Adjust the position of the picker tool using the following methods to make sure that the square is in an area with neutral colour.
    - Drag the picker tool on the screen to move its position.
    - Double-tap the area above, under, or on left or right of the square metering area to fine-tune the position of the picker tool in the corresponding direction.
  - d. Press the circle button under the touch display to apply the values. Press the delete button to exit without saving the values.
  - e. The manual white balance icon and colour temperature value will be displayed on Control Screen after the values are applied. These values will be used for the following captured images.
2. **Focus Mode**  
Includes AF and MF. When AF is selected, users can tap the icon to the right of the AF icon to enable or disable face detection. Refer to the Focus Modes section for more information.
  3. **ISO**  
Select ISO value. Users can also select ISO value in Live View.
  4. **Aperture**

## 5. Shutter Speed

When using the electronic shutter, there will be an E symbol in front of the shutter speed.

## 6. Exposure Scale and EV

Exposure scale is the same as in Live View. Automatic Exposure Mode (A/S/P) displays the current exposure compensation. Manual Exposure Mode displays the value of light metering. EV on the right side of the scale displays the current exposure value.

## 7. Flash Exposure Compensation

This icon will appear when a flash is mounted. Tap to set the flash exposure compensation.

## 8. Exposure Mode

Includes manual, aperture, shutter, program, and full auto. Refer to the Exposure Modes section for more information.

## 9. Exposure Metering

Includes centre weighted, spot, and centre spot.



**Centre Weighted:** Used for light situations where there is no particular dominance of light or dark areas across the tonal range. This takes into account approximately 25% of the image seen in Live View.



**Spot:** The sensitive area is equivalent to approximately 2.5% of the image area (the central spot in Live View). Any parts of the image outside of this area will not affect the exposure reading. This provides a very accurate measurement of specific tones. Also suitable for tonal comparison measurements. Spot area is marked in Live View and will follow any movement of the focus point.



**Centre Spot:** Emphasizes the central section of the focusing screen equivalent to approximately 25% of the image. This provides a balanced assessment and is a typical choice where the main subject is in the centre of the image.

## 10. Drive Mode

Includes single, continuous, self-timer, interval, exposure bracketing, and focus bracketing. View or set the shooting parameters for each mode on the right of the mode list. Refer to the Drive Modes section for more information.



## 11. Remaining Frames, Storage Location, and Storage Status

**Remaining Frames:** Displays the number of photos that can be stored to the available storage according to the selected storage location and image format. When the secondary storage is used as backup in the Storage settings, the location with less storage between the SSD and CFexpress memory card will be used to calculate the remaining frames.





**Storage Location:** Displays the selected storage.



Orange refers to the storage location in use. The primary slot and the backup secondary storage used will appear in orange.

	A white border indicates extra storage that is set to overflow in the Storage settings.
	When the CFexpress memory card is set to overflow but without any memory card inserted, the icon will display without a white border.

Storage Status: Displays the data writing status and error statuses. Includes:

	Current read write. This storage status icon will appear on the left of the remaining frames.
	No memory card. This icon will appear when the secondary storage is set to backup but without any memory card inserted so that the camera cannot store images.
	Memory card error.
	Slow read/write speed.

## 12. Camera Body Model

When using with cameras other than the 907X, the camera body set in the settings will be displayed here.

## 13. Live View (LV)

Tap to enter Live View.

## 14. Shutter Release Button

When using with cameras other than the 907X and with the camera body set to Any (Electronic Shutter), the shutter release button will appear. Tap to make a capture.

## Browse Mode

Press the browse button under the touch display to enter Browse Mode. View captured images and related information, rate the images, and delete images in Browse Mode. Browse Mode shows the standard information by default. Press the circle button under the touch display or tap the bottom area on the touch display to switch between different information displays, including:

Standard

Capture Details + Image Rating

Separate Histogram RGB

Luminance Histogram

None (image only)

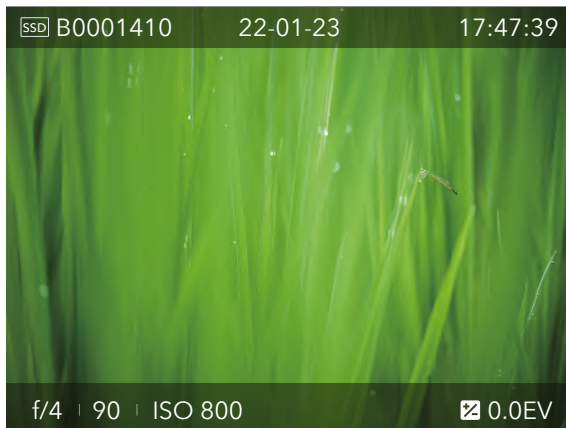

Refer to the Image Browsing section for more information.

## 2.3 EXPOSURE MODES

The digital back supports five exposure modes, including a manual mode and four automatic modes. Select the exposure mode in the settings on Control Screen.

When using with the 907X camera body, all modes are available. When using with other cameras, only Manual Exposure mode is available. When the camera body is set to Any (Electronic Shutter), Aperture Priority Automatic mode is also available.

<b>M</b>	Manual Exposure Mode
<b>A</b>	Aperture Priority Automatic Mode
<b>S</b>	Shutter Priority Automatic Mode
<b>P</b>	Program Automatic Mode
<b>AUTO</b>	Full Automatic Mode (ISO and WB are automatically set)

### Selecting Exposure Mode

On Control Screen, tap the exposure mode icon on the lower left corner and then tap on the pop-up menu to select the corresponding mode. When using with the 907X camera body, users can also use the control dial on the camera body to switch between options in the pop-up menu and press the function button to confirm the selection.

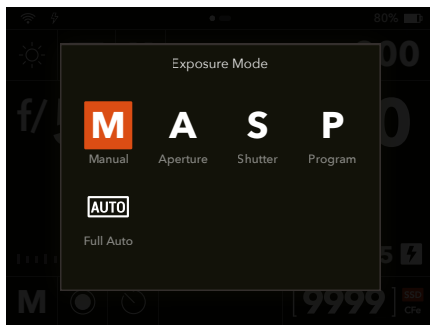
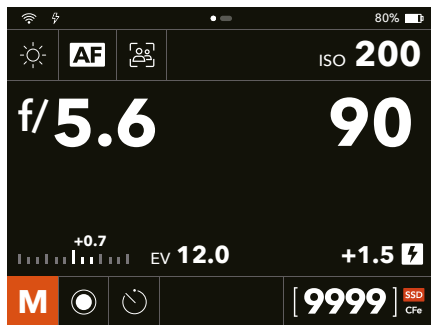

## Manual Exposure

Manual Exposure mode provides total control of the shutter and aperture settings. Users can manually determine the aperture and shutter speed. When using with the 907X camera body, set the aperture using the control dial on the camera body.

In Manual Exposure Mode, the exposure scale is displayed in Live View.

The standard exposure setting is obtained when the value displayed over the exposure scale is 0.0 and positioned above the central index.

The value appearing elsewhere than above the central index indicates the deviation from the standard exposure.

As shown in the figure, a “+ 0.7” above the scale in the display (A) indicates a “0.7 EV overexposure” setting. Conversely, a “-2”, for example, would indicate a “2 EV underexposure” setting. In Manual Exposure Mode, the aperture settings (B) and shutter speed (C) are conventionally indicated to the right of the exposure scale.

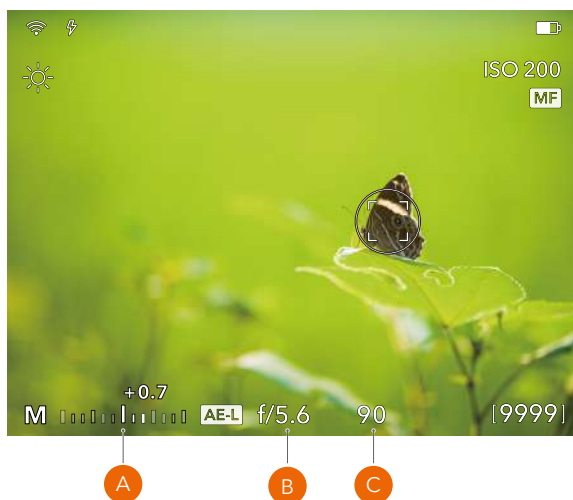

- 1 step, 1/2 step, or 1/3 step adjustment for the aperture value is also reflected on the display, according to the increment step size setting. For example, a setting between f/8 and f/11 will appear as f/9.5 if 1/2 step is selected.

## Automatic Exposure

Automatic Exposure Mode includes three semi-automatic modes and one fully automatic mode for shutter speed and aperture control.

### Aperture Priority (A)

Set on Control Screen or toggle the control dial on the 907X camera body to adjust the aperture. The shutter speed will be set automatically for optimal shooting performance.

### Shutter Priority (S)

Set on Control Screen or toggle the control dial on the 907X camera body to adjust the shutter speed. The aperture will be set automatically for optimal shooting performance.

### Program (P)

In this mode, the camera selects an aperture and shutter speed combination to suit various requirements and applications. The aperture and shutter speed have preset appropriate limitations according to the EV which is measured in a user-selected metering method. Users can shift the aperture and shutter speed combination using the control dial on the 907X camera body.

### Full Auto (AUTO)

In this mode, ISO, aperture, and shutter speed are set by the camera automatically. No adjustments can be made except switching the focus mode. White balance is set to Auto, the metering method is Centre Weighted. Single, Continuous, and Self-Timer Drive Modes are supported.

## Auto Exposure Lock

In Automatic Exposure modes (A/S/P/AUTO), AE lock is activated automatically.

## 2.4 FOCUS MODES

When using with the 907X camera body, autofocus (AF) and manual focus (MF) are supported. Face detection in AF is also available. Select the focus mode on Control Screen. When a lens with the push-pull focus ring is used, users can switch between AF and MF.

When using with other cameras, only manual focus (MF) is available.

### Selecting Focus Mode



- When a lens with the push-pull focus ring is used, only MF is available when the focus ring is pushed to the front position. Users cannot select other focus modes.

On Control Screen, using the button on the 907X camera body or the touch display:

Tap the focus mode icon on the upper left corner of the screen. Tap the corresponding mode in the pop-up menu or toggle the control dial on the 907X camera body to switch between options, and then press the function button to apply the mode.

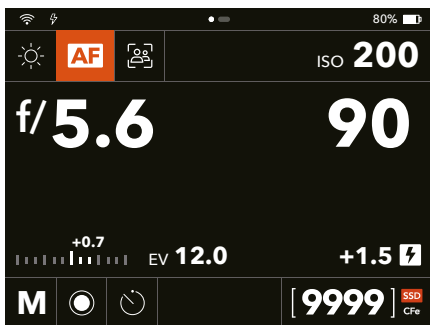



Using the push-pull focus ring:

When a lens with the push-pull focus ring is used, push the focus ring to the front position to enter MF. Pull the focus ring to the rear position to go back to the focus mode before entering MF. Refer to the corresponding lens manual for more information.

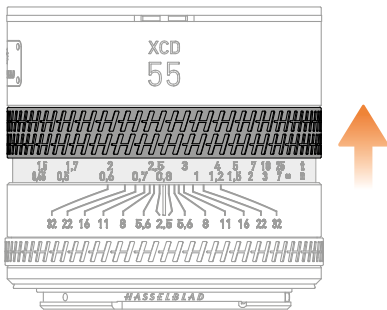

## Auto Focus

Activate autofocus by half-pressing the shutter release button.

Focus is determined by the max contrast within the central marked area. When the contrast is not high enough, focus cannot be set correctly.

The focus point display varies in different scenarios. See the illustrations here and the following descriptions.



- Some H System lenses do not support AF. The camera will default to Manual Focus Mode for such lenses.



White focus point.

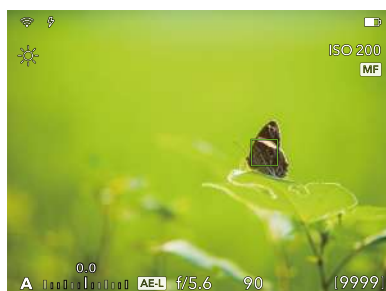

Green focus point. AF set correctly.

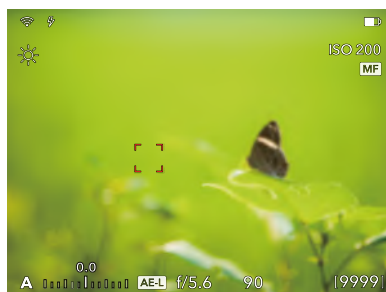

Red focus point. AF analysis failed to focus.

In AF, the shutter release will be locked until the camera finds the optimal focus setting to make sure that no images are made while not focused. The lock time is short in normal conditions. In good lighting conditions the camera will set the focus correctly in a short time.

## Focus Point

The square focus point in Live View indicates the status of the AF system. Activate autofocus by half-pressing the shutter release button.

Grey, white outline: Normal. Autofocus is not analysing the subject. (1)

White, black outline: Autofocus is ongoing. (2)

Green: Autofocus performed and focus is correctly set. (3)

Red: Autofocus failed to focus and focus is not correctly set. (4)

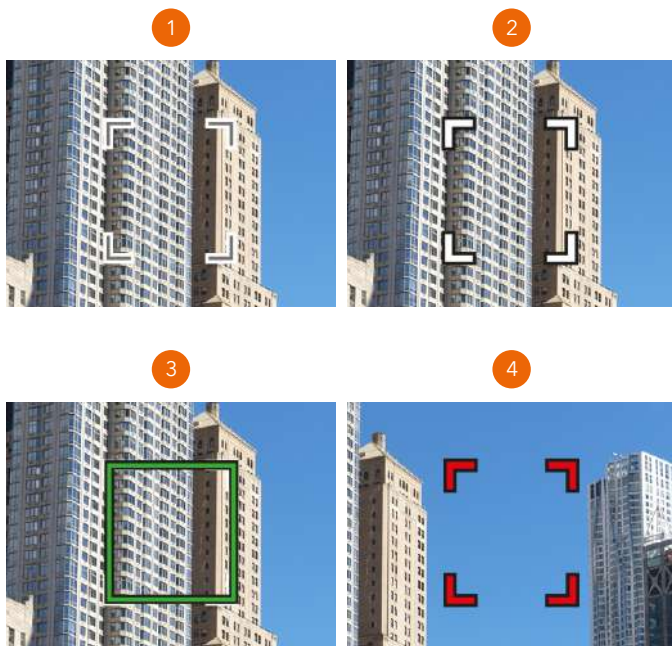

Users can adjust the focus point. Refer to the Moving and Adjusting Focus Point section for more information.

## Autofocus Single

Half-press the shutter release button to focus. Focusing will not restart if the camera or the subject moves.



- In this mode, the lens will focus at one distance and will remain focused at that distance while half-pressing and holding the shutter release button. In this way, users can focus on the subject, temporarily positioned within the focusing zone, and half-press and hold the shutter release button and recompose. As a result, the focus remains on the subject chosen even though it is now outside the focusing zone.
- For objects close to the camera and with wide-angle lenses, it is recommended to move the focus point into focus.

## Face Detection

Face detection is supported in AF. When a face is detected, autofocus will focus on the detection result area. Face detection includes Auto and Manual modes. See details below.

### Enable/Disable

On Control Screen, make sure that the focus mode is set to AF, tap the icon to the right of the AF icon, and select the face detection mode to Auto or Manual. The corresponding icon will appear in Live View under the ISO value.

Select Off on Control Screen if face detection is not needed.

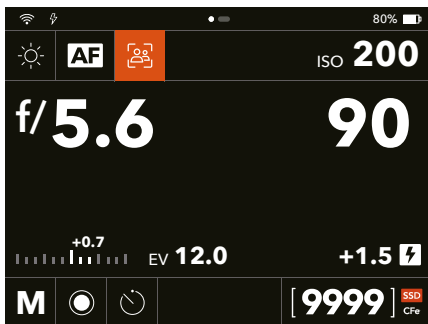

## Face Detection - Auto

In Auto mode, multiple results can be detected and marked with the grey frame (1) or (2).

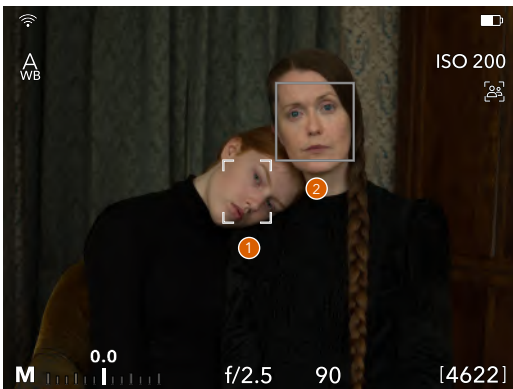

1. Multiple faces are detected. Only one of the detection results will display the grey frame (1), indicating that it will be focused on after pressing the shutter release button. Other detection results will display the grey frame (2).
2. Switch between the detection results using the following methods.
  - Tap the detected face result on the touch display to select it. The selected result will be displayed in the grey frame (1).
  - When using with the 907X control grip or the lens with the control ring, users can assign a customisable button on the control grip or lens control ring, or move the joystick on the 907X control grip left and right to switch the face detection result. The selected detection result will be displayed in the grey frame (1).
3. Make sure that the focus point is in the desired detection result area. Half-press the shutter release button to focus on the subject. The grey frames for other detection results will disappear. Release the shutter release button and the camera will restart the face detection process and display the detection results.

## Face Detection - Manual

In Manual mode, only one detection result will be displayed at most, marked with the grey frame (1).

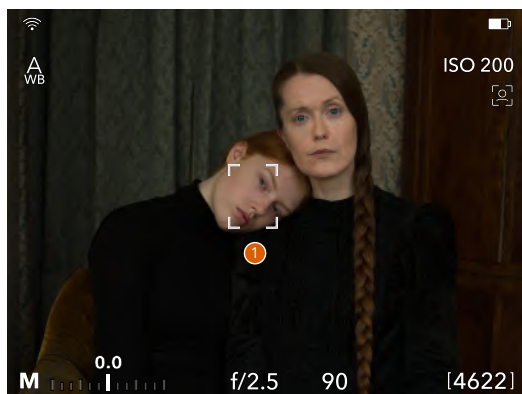

1. When a face is detected, the detection result will be displayed in the grey frame (1).
2. Make sure that the focus point is in the desired detection result area. Half-press the shutter release button to focus on the subject. Release the shutter release button and the camera will restart face detection and display the detection results.



- In both Auto and Manual modes, users can press the delete button under the touch display to clear the current face detection results. Tapping the touch display to move the focus point (when Move AF Point is enabled) can also pause the face detection. A few seconds after the operations mentioned above, the camera will restart face detection and display the detection results.
- If no face is detected, a normal focus point will be displayed.

## Manual Focus

### Manual Focus in Live View

1. Double-tap the touch display or press the rear scroll wheel (when set to zooming in) to zoom in on the image to 100% of the original size to check the focus area details.
2. Rotate the focus ring of the lens to focus.
3. Double-tap again to zoom out of the image to full image.

Users can also activate autofocus by tapping on the touch display when Touch AF is enabled in the settings. Follow the instructions below to set:

Go to Main Menu > Focus, scroll to the bottom, and then enable Touch AF.

There are three focus assists for manual focus, Focus Peaking, Auto Zoom, and Focus Indicator. Refer to the following section for more information.

If Auto Zoom is selected, the camera will automatically zoom in to 100% when rotating the focus ring. It will return to full image after a few seconds of inactivity.

### Enabling MF Assist

Go to Main Menu > Focus > MF Assist, and then select the desired assist.



- In Full Auto Exposure Mode, MF Assist is set to Focus Indicator when using Manual Focus Mode. Users cannot change the setting.
- When using with cameras other than the 907X, only Focus Peaking is available for MF assist.

## Focus Peaking

The Focus Peaking function is a manual focus tool to help users identify what areas of the subject are in focus. When Focus Peaking is enabled, rotate the focus ring to adjust the focus manually and the focused area of the subject (cyan in the illustration, can be set to another colour) moves in depth as the focus moves.



Subject not in focus when Focus Peaking is active



Focus Peaking display when subject is in focus



## Auto Zoom

If enabled, the camera will automatically zoom in to 100% from where the focus point is located when rotating the focus ring. This makes it easy for the users to check whether the focus is set correctly on the subject or not.



Live View

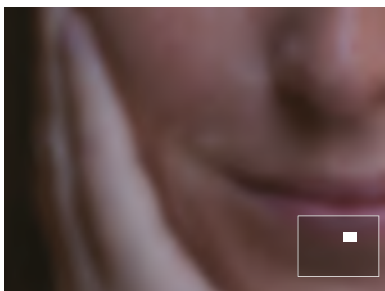

Auto Zoom to 100%. Subject not in focus.

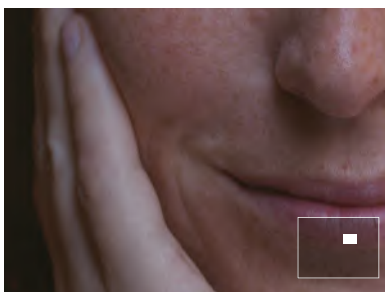

Auto Zoom to 100%. Focus set correctly.

## Focus Indicator

If enabled, the focus indicator will appear in Live View.



The focus indicator can indicate the relationship between the focus and subject and show the direction to rotate the focus ring.

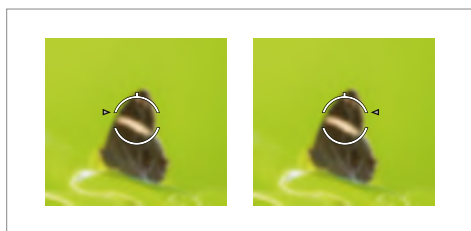

Grey triangle: The focus is too far from the subject. Users can try to rotate the focus ring clockwise or counterclockwise to make the triangle turn white.

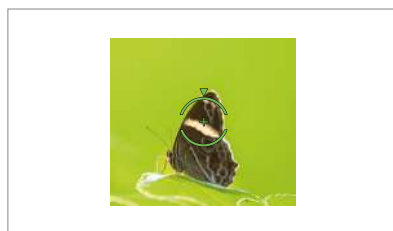

Green triangle and circle: The focus is correctly set on the subject. Focus completed.

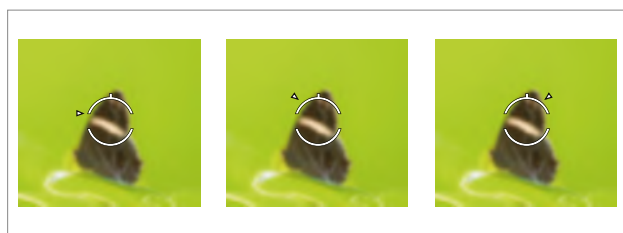

White triangle: The focus is close to the subject. Users can rotate the focus ring to focus. Rotate the focus ring clockwise when the triangle is located on the left of the focus indicator. Rotate the focus ring counterclockwise when the triangle is located on the right.

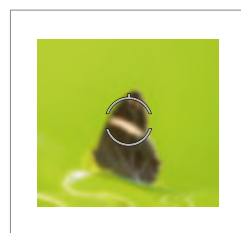

Grey circle: Failed to focus.

## Moving and Adjusting Focus Point

When using with the 907X camera body, users can move the focus point and adjust the focus point size while shooting. Make sure that Move AF Point is enabled before use. Follow the instructions below to set:

Go to Main Menu > Focus, scroll to the bottom, and then enable Move AF Point.

In Live View on the touch display, tap the display or swipe on the display to move the focus point to the target position. Spread or pinch to zoom in or out on the focus point.









- In Full Auto Exposure Mode, the focus point can only be moved using touch operations on the touch display. Users cannot adjust the focus point size.

## 2.5 DRIVE MODES

The digital back supports drive modes including Single, Continuous, Self-Timer, Interval, Exposure Bracketing, and Focus Bracketing. Go to Control Screen to set.

When using with the 907X camera body, all modes are available. When using with other cameras and with the camera body set to Any (Electronic Shutter), all modes except Focus Bracketing are available. When the camera body is set to other options, only Single Drive mode is available.

	Single
	Continuous
	Self-Timer
	Interval
	Exposure Bracketing
	Focus Bracketing

### Selecting Drive Mode

On Control Screen, tap the drive mode icon at the bottom and tap on the pop-up menu to select the corresponding mode. When using with the 907X camera body, users can also use the control dial on the camera body to switch between options in the pop-up menu and press the function button to confirm the selection.

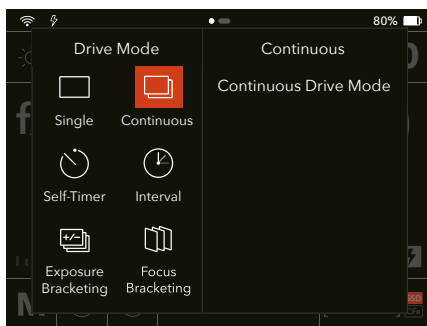
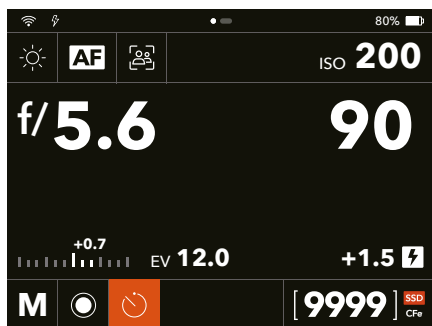

When Self-Timer, Interval, Exposure Bracketing, or Focus Bracketing is selected, the current configuration will be displayed to the right of the mode list.

Tap any of the parameters to enter the settings menu for adjustment.

## Single

In this mode, the camera will make one exposure only regardless of how long the shutter release button is pressed.

## Continuous

The camera will make exposures as long as the shutter release button is pressed.

## Self-Timer

The camera will wait a preset time to make the exposure after the shutter release button is pressed.

Time: A delay between shutter release and exposure.

Sound: Select the prompt sound volume for the countdown of Self-Timer.

When Finished: Determines if the function shall be active after a completed cycle or not. If set to Exit, the drive mode will be set to Single or Continuous automatically after exposure.

After the shutter release button is fully pressed, the touch display will show the countdown screen. The camera will take photos automatically after the preset countdown ends. Press the delete button under the touch display to exit during the countdown.

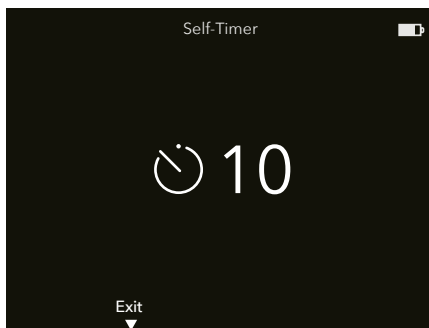
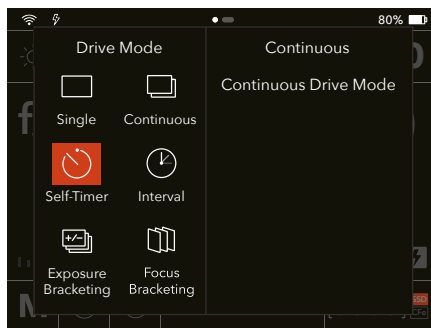

## Interval

The camera will make a pre-determined number of exposures with a preset interval time.

Time: The time between exposures.

Frames: How many exposures will be made.

Initial Delay: A delay between shutter release and first exposure.

Metering: Exposure metering for all frames or first frame only.

When Finished: Determines if the function shall be active after a completed cycle or not.

Configure interval shooting parameters and press the shutter release button to start interval shooting. If Initial Delay is set, the camera will start a countdown before shooting the first image. Shooting will start after the preset delay ends.

The touch display will show information such as interval time countdown and shot frames/total frames during the sequence. Press the delete button to exit interval shooting if it is required to exit before completion.

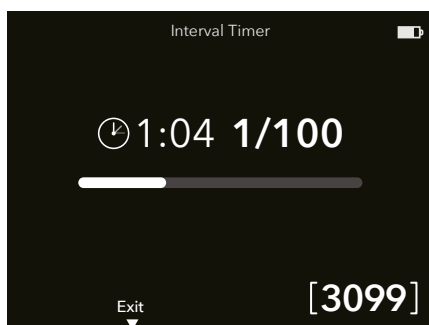
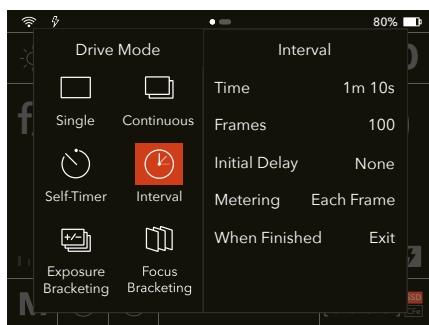

- Live View is disabled after interval shooting starts. If Preview is enabled in the Display settings, users can preview the previously shot image while shooting. The interval shooting information will display over the preview screen.
- When the interval time is set to 25s or more or the shutter speed is set to 1/6s or more, the camera will turn off the display to save battery 5 seconds after the shooting starts. The display will light up automatically before the next image is shot. Users can also wake up the display by pressing the ON/OFF button.
- Interval shooting on the camera is disabled when the camera is connected to the Phocus software on the computer or the Phocus Mobile 2 app on a mobile device. In this case, use the capture sequencer in Phocus to achieve interval shooting.

## Exposure Bracketing

The camera will automatically make a pre-determined number of exposures with a preset exposure adjustment difference between each frame.

Amount: How much exposure difference between each exposure.

Frames: The number of exposures in the sequence.

Initial Delay: A delay between shutter release and first exposure.

Param in M: Which of aperture or shutter speed to change if exposure bracketing is used in Manual Exposure Mode.

Sequence: The order to change the exposure compensation for each frame.

When Finished: Determines if the function shall be active after a completed cycle or not.

Configure exposure bracketing parameters and press the shutter release button to start exposure bracketing. If Initial Delay is set, the camera will start a countdown before shooting the first image. Shooting will start after the preset delay ends.

The touch display will show information such as exposure compensation and shot frames/total frames during the sequence. Press the delete button to exit exposure bracketing if it is required to exit before completed.

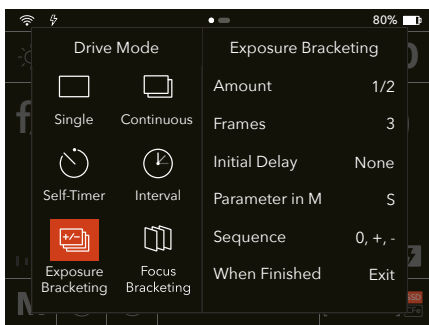

- Live View and Image Browsing are disabled after the exposure bracket starts.
- Light metering, focusing, and Auto WB is performed before the first exposure and applied to all images in sequence.
- When the shutter speed is set to 1/6s or more, the camera will turn off the display to save battery 5 seconds after shooting starts. The display will light up automatically before the next image is shot. Users can also wake up the display by pressing the ON/OFF button.
- Exposure bracketing on the camera is disabled when the camera is connected to the Phocus software on the computer or the Phocus Mobile 2 app on a mobile device. In this case, use the capture sequencer in Phocus to achieve exposure bracketing.

## Focus Bracketing

Focus bracketing can be used for different purposes. The most obvious is to achieve a larger depth-of-field by stacking images with different focus positions together in post-production. Users can also use it to pick the best image from a batch.

In Focus Bracketing mode, the camera will automatically take a preset number of images by calculating the focus shift between each image by using the preset step size. The images will be stored as separate files and users can edit them manually or use a third-party software (e.g., Helicon Focus) to merge them together into a final stacked image.

It is recommended to perform a test before actual capture to achieve optimal results.

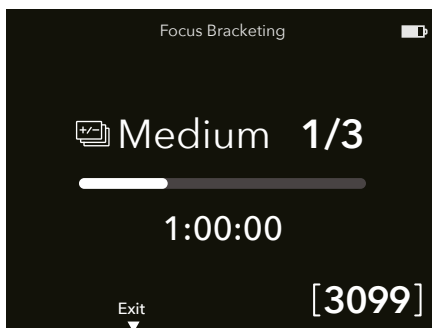
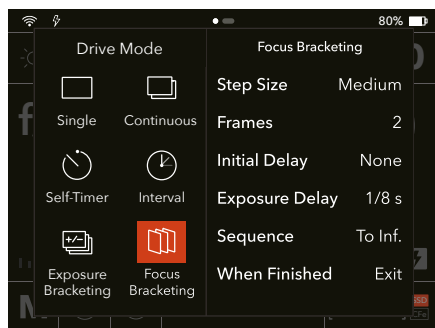

**Step Size:** The step of the focus position between frames. Refer to the following section for more information.

**Frames:** How many exposures will be made.

**Initial Delay:** A delay between shutter release and first exposure.

**Exposure Delay:** The interval time between exposure.

**Sequence:** The order to change the focus position for each frame.

- Towards Infinity

Set the focus manually or by using AF. Switch to MF if focus cannot be obtained when using AF. In this mode, focus should be set at a point (A) that is closer to the camera than the main subject. When the sequence has started, focus will be shifted towards infinity until the preset number of images have been captured or the lens has reached the infinity position.

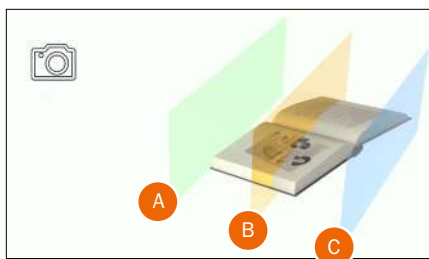



- Towards Near Limit

Set focus at a point (C) behind the main subject. During the sequence, the camera will shift focus closer and closer to the camera. The sequence will stop after the preset number of images have been captured or the lens has reached near limit.

- Symmetric

In this mode, focus should be set on the main subject (B). When the sequence has started, the camera will first take an image, then move focus to a focus point closer to the near limit, and take all of the images in the sequence, shifting focus towards infinity. The first image is an extra exposure made to ensure that there is at least one image of the main subject with perfect focus.

When Finished: Determines if the function shall be active after a completed cycle or not.

Configure focus bracketing parameters and press the shutter release button to start focus bracketing. If Initial Delay is set, the camera will start a countdown before shooting the first image. Shooting will start after the preset delay ends.

The touch display will show information such as step size and shot frames/total frames during the sequence. Press the delete button to exit focus bracketing if it is required to exit before completion.



- Use firmware version 0.1.26 or later for XCD 45P lenses and 0.6.0 or later for other XCD lenses with the focus bracketing function.
- HC/HCD lenses cannot be used for focus bracketing.
- When using a lens with the push-pull focus ring, make sure to pull the focus ring to the rear of the lens. Otherwise, focus bracketing cannot start.
- Live View and Image Browsing are disabled after focus bracketing starts. If Preview is enabled in the Display settings, users can preview the previously shot image while shooting. The focus bracketing information will display over the preview screen.
- Light metering, focusing, and Auto WB are performed before the first exposure and applied to all images in sequence.
- When the shutter speed is set to 1/6s or more, the camera will turn off the display to save battery 5 seconds after shooting starts. The display will light up automatically before the next image is shot. Users can also wake up the display by pressing the ON/OFF button.
- Focus bracketing on the camera is disabled when the camera is connected to the Phocus software on the computer or the Phocus Mobile 2 app on a mobile device.

## Step Size

For high-quality work, users should normally select Small or Medium step size. For less critical work, users can also use Large or Extra Large. Large or Extra Large can also be used in certain situations when the type of subject allows.

To find what works best for your situation, it is recommended to perform multiple tests.

The step size is related to the depth of field (DoF) produced by the camera at a given aperture. This means that the actual focus shift in the subject will be larger with a higher aperture number. For example,  $f/4$  will give a smaller step than  $f/11$ . However, before each exposure, the camera will automatically calculate the actual step size using the current focus position, focal length of the lens, aperture and pixel dimensions of the sensor.

In the subject, the DoF will grow as the focus point is moved away from the camera. The distribution of the DoF around the focus point will also be more uneven. The DoF on the far side of the focus point will grow more than the DoF in front of the focus point.

As the camera will automatically make all the calculations for users, the only thing that really needs consideration is how many images to make in the sequence. In most cases, it is recommended to set a number that is too high rather than too low. The camera will automatically stop when the lens cannot be focused further or closer.

## DoF and Step Size Visualized

To the right is a typical subject where focus bracketing could be used.

With the step size set to Medium, there will be no unsharp areas between each image. Please note that DoF is relative and how it is perceived greatly depends on the viewing magnification of the final result. The circle of confusion (CoC) is used to determine the depth of field, see also [https://en.wikipedia.org/wiki/Circle\\_of\\_confusion](https://en.wikipedia.org/wiki/Circle_of_confusion).



The image below shows how the DoF will change between captures and also how the focus step in the subject will automatically increase as the DoF is increased.

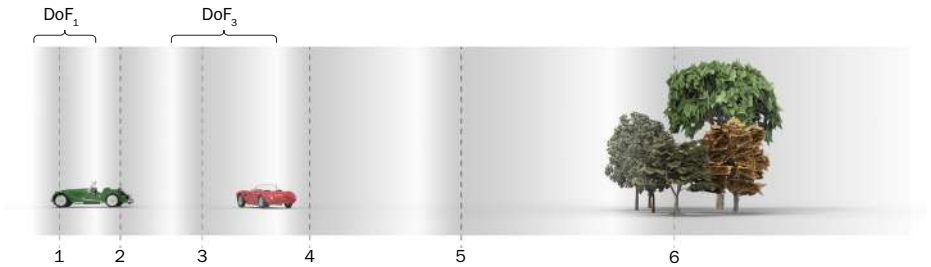

The table to the right shows the actual Circle of Confusion (CoC) used for the different step sizes. PP is the Pixel Pitch of the sensor which is the distance between two adjacent pixels.

<b>STEP SIZE</b>	<b>CoC</b>
Extra Small	$1 \times PP = 5.3 \mu\text{m}$
Small	$4/3 \times PP = 7.1 \mu\text{m}$
Medium	$2 \times PP = 10.6 \mu\text{m}$
Large	$4 \times PP = 21.2 \mu\text{m}$
Extra Large	$6 \times PP = 31.8 \mu\text{m}$

## 2.6 BUILT-IN SSD

The digital back has a built-in 1TB SSD to store images. Connect the camera to a computer to use the built-in SSD as mass storage for data read/write.

### Storing Files to SSD

Go to Main Menu > Storage > Primary Slot, and select SSD. Check the free space of the SSD in the Info section.

### Formatting SSD



- Formatting SSD will erase all the contents on the SSD. Operate with caution.

1. In the Storage settings, scroll to the bottom and select Format SSD.
2. Press the browse button under the touch display to perform formatting.
3. Wait for formatting to be completed.

### Checking SSD Storage Status

Check the SSD storage status on Control Screen.

### Using the SSD as Mass Storage

1. Connect camera to a computer using a USB-C cable of USB 2.0 or above.
2. Tap Mass Storage in the pop-up dialogue on the camera touch display.  will be shown on the touch display.
3. The camera SSD will be connected to the computer as a mobile storage device and data read/write to the SSD is available.



- After the camera is connected to the computer, if Skip is selected on the touch display, the built-in SSD will not be connected to the computer. Reconnect the camera to the computer and select the correct option.

## 2.7 MEMORY CARDS

Insert a CFexpress Type B memory card to expand storage. Memory cards with storage of up to 512GB are supported.

### Storing Files to Memory Card

Go to Main Menu > Storage > Primary Slot, and then select CFe. Check the free space of the CFexpress memory card in the Info section.

### Formatting Memory Card



- It is recommended to format the memory card on the camera before using it for the first time.
- Formatting the memory card will erase all the contents on the memory card. Operate with caution.

1. In the Storage settings, scroll to the bottom and select Format CFe.
2. Press the browse button under the touch display to perform formatting.
3. Wait for formatting to be completed.

### Checking Memory Card Storage Status

Check the memory card storage status on Control Screen.

## 2.8 IMAGE BROWSING

Browse Mode includes four menu levels:

- Standard Preview
- 9 View/25 View
- Folder Browsing
- Storage Location

The camera displays Standard Preview mode when entering Browsing mode. Pinch two fingers on the touch display to enter 9 View mode, and pinch again to enter 25 View mode. In 25 View mode, spread two fingers on the touch display to enter 9 View mode, and pinch two fingers or tap the back button on the upper left corner to enter the upper level.

When using with the 907X camera body, press and hold the function button, and then toggle the control dial counterclockwise to enter the upper level while clockwise for the lower level.

### Browsing Images

Press the browse button under the touch display to enter Browse Mode.

When Preview is enabled in the settings, the camera will enter Browse Mode after shooting is finished. Follow the instructions below to set:

Go to Main Menu > Display, scroll to the bottom, enable Show Preview and select the preview time in the Preview section.

Use the control dial on the 907X camera body or swipe on the touch display to switch the image to browse.

Press and hold the function button on the 907X camera body, and then toggle the control dial to zoom in or out on the image.

Spread or pinch on the touch display to zoom in or out. Double-tap the touch display to zoom in to 100% or zoom out to full image.

Press the circle button to switch the information overlay.

Press the delete button to delete the image currently displayed.

## Standard Preview Mode

The camera displays Standard Preview Mode when entering Browsing Mode. Users can view the captured images and basic settings in Standard Preview Mode.

Besides basic settings, Standard Preview Mode also includes information overlays below: Capture Details Mode, Separate Histogram RGB Mode, and Luminance Histogram Mode. Refer to the related section for more information.

1. Storage Location (SSD or CFe)
2. Capture Date
3. Capture Time
4. Aperture (f/4)
5. Shutter Speed (90)
6. ISO Setting (800)
7. Exposure Adjustment Indicator and Exposure Compensation Value (0.0 EV)



## 9 View Mode / 25 View Mode

### Viewing Images

In Standard Preview Mode, pinch two fingers together on the touch display to enter 9 View Mode. Perform the same operation to enter 25 View Mode. Scroll on the touch display to preview other images when the number of images is more than nine or 25. Select an image to view details.

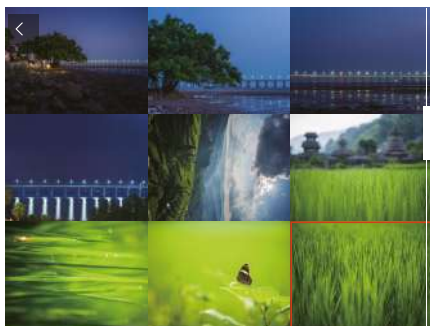

### Deleting Images in Batches

In 9 View Mode or 25 View Mode, tap and hold the image on the screen or press the delete button under the touch display to enter batch delete mode, select multiple images, and delete.

## Capture Details Mode

The Capture Details Mode displays the detailed information when captured.



## Separate Histogram RGB Mode

In Separate Histogram RGB Mode, the individual RGB channels are displayed. The Red R channel first, the Green G channel in the middle, and the Blue B channel below the Red and Green channels.

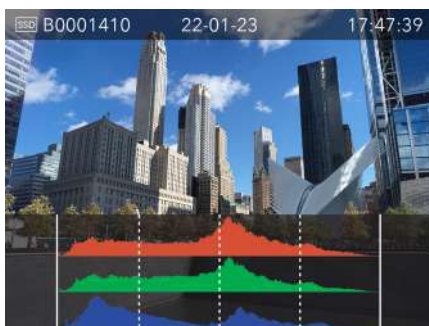

## Luminance Histogram Mode

The Luminance Histogram Mode displays the luminosity. The luminance is represented by a White Graph.

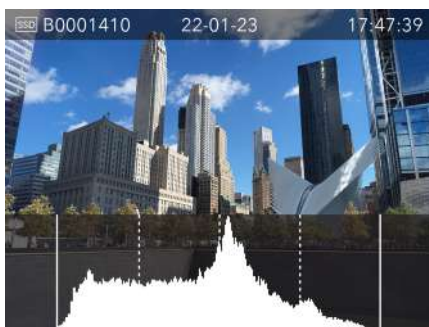



## Luminance Histogram Exposure

The histogram provides a graph that indicates the total number of pixels at each brightness level, with brightness in range from black on the left to white on the right. It is a valuable tool for evaluating images.

A well exposed shot usually has a full range of levels, while underexposed and overexposed images tend to show levels concentrated at the left or right part of the scale.

The histogram is only an indicator that should be interpreted. There are several situations in which a 'bad' histogram will match an exposure that could be perfect for the intended effect.

Study the histogram examples and the explanations below.

### Underexposure

Histogram display concentrated on the left with few pixels elsewhere indicates a likely underexposure. Many details will be lost in the shadows.

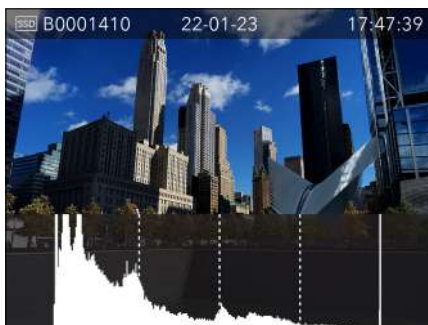

Underexposure

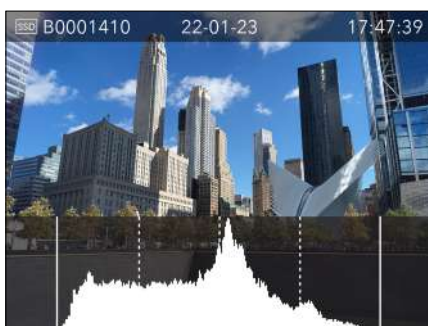

Even exposure

### Even exposure

Histogram display spread across the full range indicates a likely good exposure. There may still be a few pixels at the extremes, indicating a few spectral highlights and saturated shadows, but this is often normal in a good exposure.

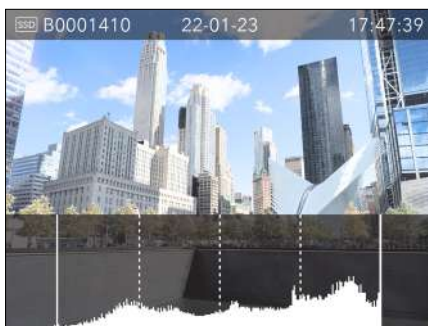

Overexposure

### Overexposure

Histogram display concentrated on the right with few pixels elsewhere indicates a likely overexposure. Many details will be lost in the highlights.

## Selecting Folder to Browse

1. Enter 9 View Mode/25 View Mode, Folder Browsing, and Storage Location successively from Standard Preview Mode.
2. Select SSD or CFexpress to browse.
3. Enter Folder Browsing Mode. When using with the 907X camera body, toggle the control dial to switch between folders, and press the function button to enter the folder.
4. Enter 9 View Mode and Standard Preview Mode successively to preview the images.

## Creating Folders

1. Enter 9 View Mode/25 View Mode, Folder Browsing, and Storage Location successively from Standard Preview Mode.
2. Select SSD or CFexpress to browse. Folders can only be created in the storage set as the primary slot.
3. Enter Folder Browsing Mode and tap the icon on the upper right corner of the touch display to create a folder. Users can also toggle the control dial on the 907X camera body to select the icon and press the function button to confirm.
4. Press the browse button under the touch display to create a folder, or press the delete button to exit.

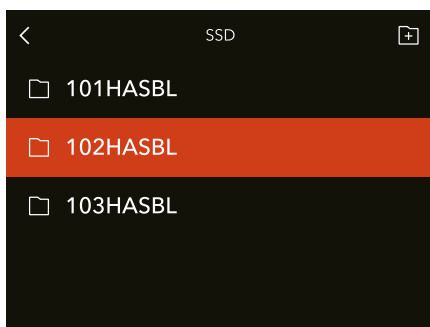

- The name of the folder is generated by the system and cannot be changed. New images will automatically be stored in the new folder.
- When the secondary storage is set to backup, after a new folder is created in the primary slot and an image is captured, the system will create the same folder in the secondary storage to back up the captured images.

## Image Rating

Images can be rated from 1 to 5 stars when browsing. The rating is written to the meta-data of the image file.

1. Enter Standard Preview Mode.
2. Press the circle button until image details are displayed. The five stars show the current rating in the lower right corner of the touch display. For an unrated image, no stars are filled.
3. To rate the image, tap the five stars.
4. The camera enters Rating Mode, showing five stars. If the image has been rated before, it will show the current rating. Otherwise, the five stars will be empty.
5. Tap the desired star to change the rating. For example, tap the fourth star to score a 4-star rating. The circle button increases the rating and the delete button decreases the rating. Press and hold the function button and toggle the control dial to change the rating when using with the 907X camera body.
6. Press the browse button to save ratings and return to Standard Preview Mode.

In Rating Mode, users can swipe left or right on the touch display or toggle the control dial on the 907X camera body to switch between images.

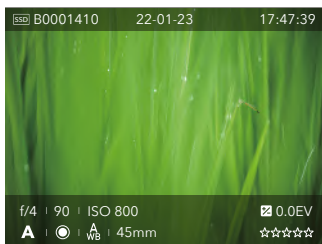

Browse Mode - Capture Details Overlay

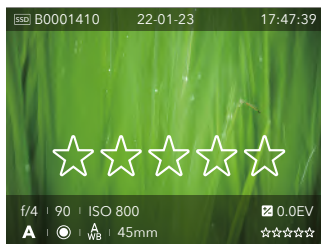

Rating Mode - Unrated

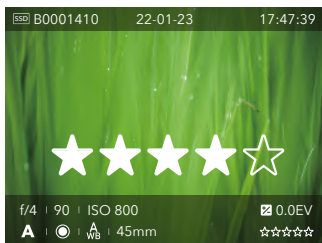

Rating Mode - Rated 4 stars

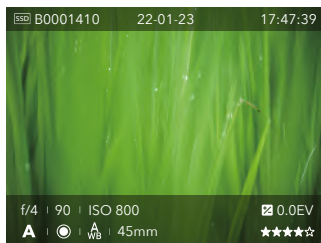

Browse Mode - Rated 4 stars



- For an efficient workflow while rating multiple images, stay in Rating Mode and switch to the next or previous image.

## 2.9 LENS DATA SELECTION

For images captured by the CFV 100C with cameras other than the 907X, users can select lens data for the image in Browse mode. The data is written to the meta data of the image file.

1. Enter Standard Preview mode.
2. Press the circle button or tap the bottom of the touch display until image details are displayed.
3. Tap  in the detailed information and select parameters, such as lens, aperture, and distance in the pop-up menu. The available lenses in the list include the lens models selected in the settings only. This can be configured in Main Menu > General > My Lens.
4. Press the browse button to save the lens data and return to Standard Preview mode.

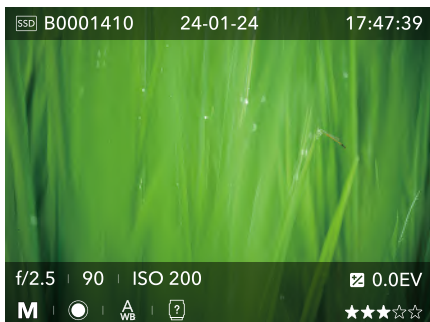

## 3 SETTINGS

## 3.1 MAIN MENU

In Live View, press the menu button under the touch display twice to enter the main menu.

On Control Screen, press the menu button once or swipe left on the screen to enter the main menu.

Settings vary depending on the cameras used with the CFV 100C.

When using with the 907X camera body, Main Menu includes frequently used settings, such as Exposure, Focus, Quality, Crop Modes, Flash, Display, Power, Storage, Wi-Fi, and General Settings.

When using with other cameras, Main Menu includes frequently used settings, such as Focus, Quality, Crop Modes, Camera Body, Display, Power, Storage, Wi-Fi, and General Settings. When the camera body is set to Any (Electronic Shutter), Exposure Settings are also available.

Tap on the screen to enter the settings menu. Swipe right in a sub-menu to return to the previous screen.



- The adjustable parameters vary depending on the exposure mode and lens in use. Parameters that cannot be adjusted will be displayed in a grey colour.

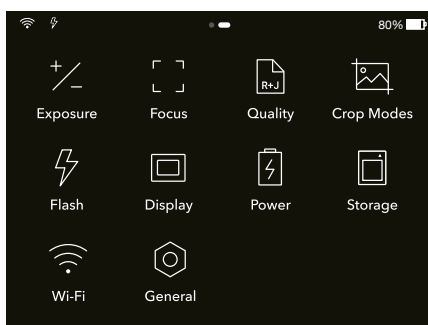

Using with the 907X camera body

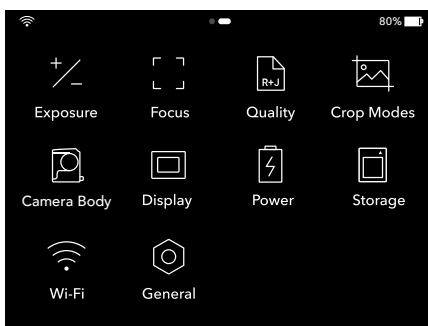

Using with other cameras

## 3.2 EXPOSURE SETTINGS

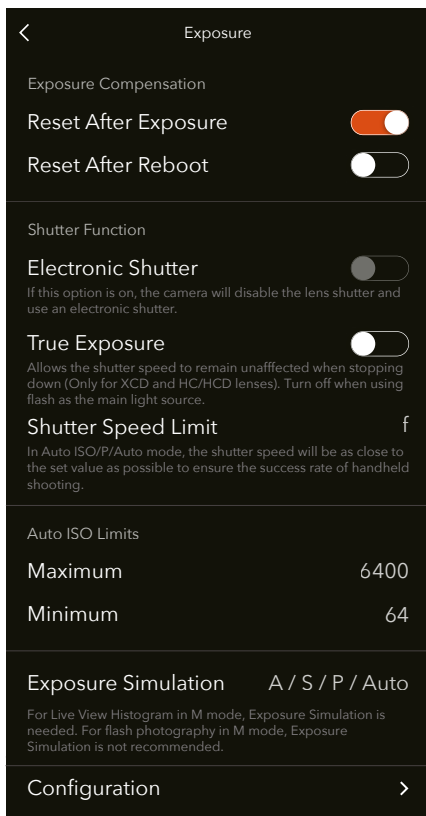

### Exposure Compensation

Main Menu > Exposure > Exposure Compensation

#### Reset After Exposure

Reset the exposure compensation and AE-L status after capture or the last exposure in a series.

#### Reset After Reboot

Reset the exposure compensation and AE-L status after powering on the camera.

## Shutter Function

Main Menu > Exposure > Shutter Function

### Electronic Shutter

Select On or Off. When electronic shutter is enabled, the camera will disable the lens shutter and use an electronic shutter in the sensor instead. Electronic shutter is indicated with an E symbol in front of the shutter speed in Live View and on Control Screen.

Note the following limitations with electronic shutter:

- The electronic shutter may not capture a subject clearly with fast movements or when shooting handheld. It is recommended to capture a stationary subject or using a tripod.
- It is recommended to use the mechanical shutter to ensure image quality when ISO 6400 or above is set.
- Shutter speed range is 68 min to 1/6000s.
- Flash is disabled.
- True exposure is disabled.

### True Exposure

Select On or Off.

Determines whether the exposure is automatically adjusted to create a true exposure setting. On allows the adjustment. Off retains the normal setting.



- If using flash/strobe as the main light source and 1/800s or shorter shutter speed (depending on lens type), make sure to disable true exposure.
- The true exposure feature is designed to keep the shutter speed unaffected by the aperture value.



## True Exposure Explained

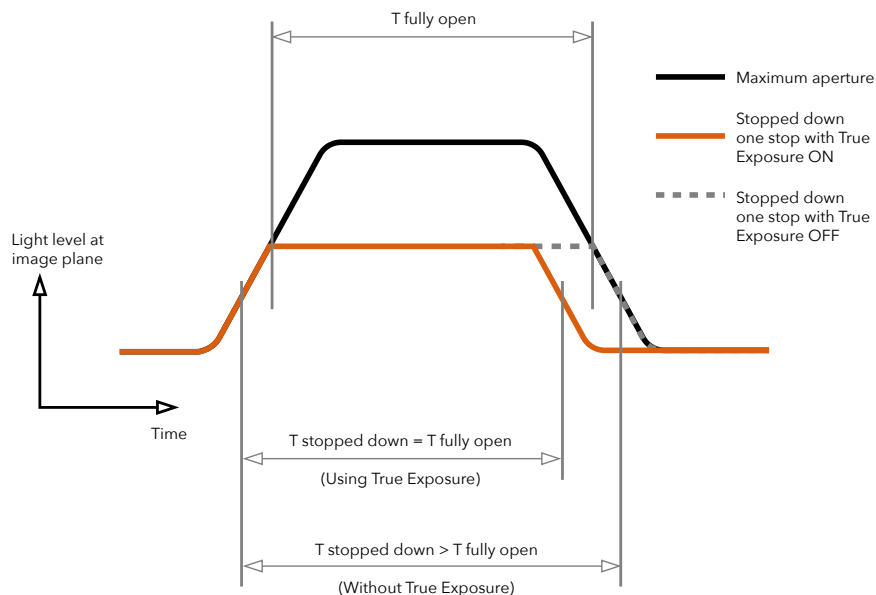

True Exposure is an XCD and HC/HCD lens function that allows the shutter speed to remain unaffected when stopping down. This effect is perhaps not so commonly understood as it is restricted specifically to integral lens shutters as opposed to focal plane shutters.

When a lens is stopped down, the effective shutter speed becomes longer, consequently affecting the set exposure. At slow shutter speeds the effect is minimal but at faster speeds, e.g. 1/500s, the effect becomes clearly visible. Automatic compensatory measures in speed setting adjustments are employed.

As compensation can only be put into effect where speeds can be adjusted, this prevents the possibility of adjusting the fastest speed. To counter this, compensatory adjustments are therefore made to the aperture instead to retain the set exposure. This compensation is not always required and when using flash/strobe as the main light source it is actually undesirable because compensation will result in underexposure. Therefore, when using flash/strobe as the main light source, disable true exposure in Main Menu > Exposure > True Exposure on the touch display.

Download a complete explanation of this situation from [www.hasselblad.com](http://www.hasselblad.com).

## Shutter Speed Limit

The shutter speed limit can be set either directly or as a function of focal length.

For example, when a 45mm lens is in use and the Shutter Speed Limit setting is 2f, the shutter speed limit will be 1/90s.

In Auto ISO/P/Full Auto Mode, the shutter speed will be as close to the set value as possible to ensure the success rate of handheld shooting.

**Auto ISO:** Sets the slowest shutter speed before ISO will be increased.

**P:** If the calculated shutter speed is slower than the set value, the aperture value will be changed instead of shutter speed.

**Full Auto:** If the calculated shutter speed is slower than the set value, the aperture value will be changed instead of shutter speed.



- The shutter speed limit can still be exceeded in some cases. For example, if using A Mode and the maximum ISO limit is already reached and there is not enough light, the shutter speed limit will be exceeded as a last resort to get a proper exposure.

## Auto ISO Limits

Main Menu > Exposure > Auto ISO Limits

Set the maximum and minimum ISO values for when Auto ISO is set.

After configuration, when ISO is set to Auto in A, S, or P Exposure Mode, the ISO is set automatically by the camera. It is unable to exceed these maximum and minimum limits.

## Exposure Simulation

Main Menu > Exposure > Exposure Simulation

In Live View the display will simulate the final image exposure.

Select A/S/P/Auto or A/S/P/Auto/M to enable the function in the corresponding exposure mode.



- Exposure Simulation will not display a correct result when using the camera with a flash. For example, when shooting with a flashlight indoors, normally, Exposure Simulation displays an image that is too dark in Live View due to weak light conditions. It is recommended to disable Exposure Simulation in Manual Exposure Mode before shooting with a flash.
- When autofocus is enabled and is analysing the subject, Exposure Simulation is deactivated to let the autofocus system operate in optimal conditions. When the autofocus process is completed, Exposure Simulation is automatically activated again.
- When using Exposure Simulation with the exposure settings set to very high overexposure or very low underexposure for the actual light conditions, Live View will display a very light or very dark image. In extreme cases, it results in a completely overexposed white image or a completely underexposed black image. In these cases, check the exposure scale on the bottom left in Live View while adjusting the exposure settings to maintain desired exposure.

## Configuration

Main Menu > Exposure > Configuration

### Exposure Lock

#### Out of Range

If enabled, it is not able to make an exposure after pressing the shutter release button when the aperture or shutter speed is out of range.

### Increment Step Size

#### Exposure

Select the step size when adjusting the exposure for a single step. Options are 1 step, 1/2 step, and 1/3 step.

#### Exposure Adjustment

Select the step size when adjusting the exposure compensation for a single step. Options are 1 step, 1/2 step, and 1/3 step.

### B/T Mode

#### Show B/T Mode

If enabled, B and T will appear next to 1.0s in the shutter speed list in Manual Exposure Mode.

To capture images when B Mode is selected, press and hold the shutter release button until exposure ends.

To capture images when T Mode is selected, press the shutter release button once to start capture and release, and press the shutter release button again or Exit when exposure ends.



- When using with cameras other than the 907X, use a shutter cable to trigger the B mode or T mode.

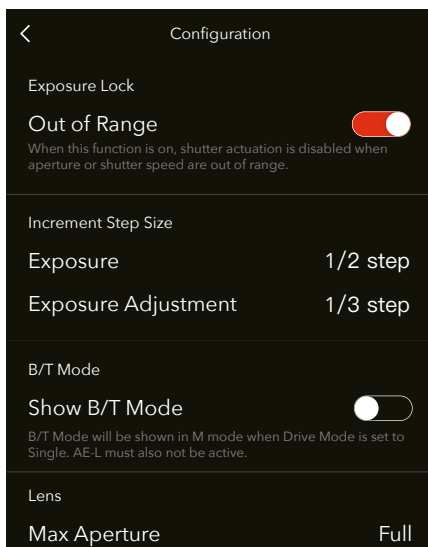

## Lens

### Max Aperture

Select to use a fully open round aperture or a normal aperture at the maximum setting.

Full: A fully open round aperture. For XCD lenses only.

Normal: Standard setting. This can minimise the risk of internal reflections.

Using the XCD 90 lens as an example, the Normal setting can cause a polygonal look for the out-of-focus areas, while the Full setting will create a smoother and round look for the out-of-focus areas with all the leaves fully open.



Image detail with Normal setting



Image detail with Full setting



Normal



Full

## 3.3 FOCUS SETTINGS

When using with cameras other than the 907X, settings for Focus Peaking for MF assist are only supported.

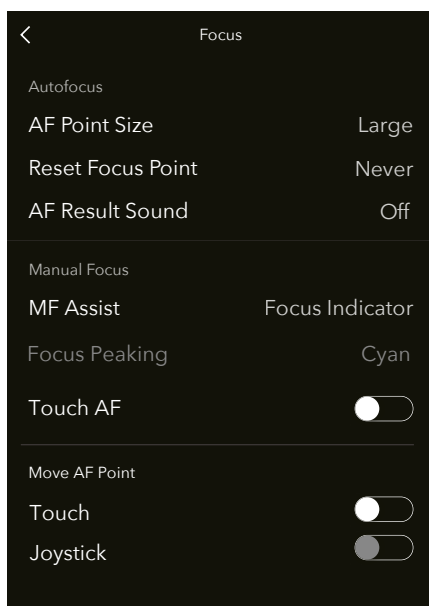

### Autofocus

Main Menu > Focus > Autofocus

#### AF Point Size

Select the focus point size displayed in Live View between large and small. The number of focus points varies depending on the focus point size.

Users can also adjust the focus point size in Live View. Refer to the Moving and Adjusting Focus Point section.

#### Reset Focus Point

Set whether to reset the focus point to the centre of the screen after each exposure.

Select Never if it is required to fix the focus point in a certain location.

#### AF Results Sound

Select the sound for a failed or successful focusing result between Low, Medium, and High. Users can also turn off the sound by selecting Off.

## Manual Focus

Main Menu > Focus > Manual Focus

### MF Assist

Select from the following method for MF assist in Manual Focus Mode.

**Focus Peaking:** In Manual Focus Mode, the focus area will be shown in the preset peaking colour.

**Auto Zoom:** The camera will zoom in to 100% automatically when rotating the focus ring in Manual Focus Mode. Refer to Auto Zoom in the Manual Focus section for more information.

**Focus Indicator:** In Manual Focus Mode, the focus point will display as a focus indicator to indicate whether the focus is correctly set. Refer to the Focus Indicator section for more information.

**None:** No MF assist.

### Touch AF

If enabled in Manual Focus mode, tap on the touch display to activate autofocus.

## Move AF Point

Main Menu > Focus > Move AF Point

### Touch

If enabled, users can adjust the focus point position and size in Live View on the touch display. Refer to the Moving and Adjusting Focus Point section for more information.

### Joystick

If enabled when using with the 907X and 907X control grip, users can move the focus point using the joystick on the control grip.

## 3.4 QUALITY SETTINGS

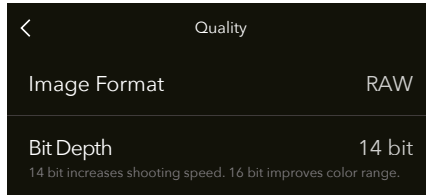

### Image Format

Main Menu > Quality > Image Format

Select the format of the still images.

### Bit Depth

Main Menu > Quality > Bit Depth

When the image format is selected to the option including RAW, select the colour depth of the images between 14 bit and 16 bit.

Using 16 bit, the camera can acquire most information for the image and restore more details with less noise, which is convenient for users to perform post-processing and creation.

Using 14 bit, users can experience faster capture and decreased blackout time between shots.

Files for both two settings have the same size in storage.



## 3.5 CROP MODES SETTINGS

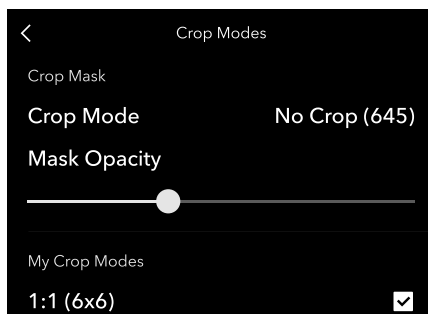

### Crop Mask

Main Menu > Crop Modes > Crop Mask

### Crop Mode

Select the mode of cropping for Live View and captured images. Options for the crop mode settings are the checked modes in the My Crop Modes section on the screen.



- After converting the images captured with a crop mask in the 3FR format to FFF format, the crop mask can be modified or removed in the Phocus software.
- A customisable button can be used to switch the crop mode in Live View quickly when the button is set to Crop Mode Next or Crop Mode Previous. Press and hold the button to return to No Crop.

### Mask Opacity

Set the opacity of the area outside the crop mask. A slider on the left indicates high transparency. A slider on the right indicates that the area is opaque, shown in black.

### My Crop Modes

Main Menu > Crop Modes > My Crop Modes

Check the boxes for different crop modes so that the modes can be shown in the options for the crop mode settings.



- 3:2 Crop (24x36) is only available when using electronic shutter and lenses other than XCD or HC/HCD. This mode is suitable for full frame lenses with an adapter.

## 3.6 FLASH SETTINGS

This menu will appear when using with the 907X.

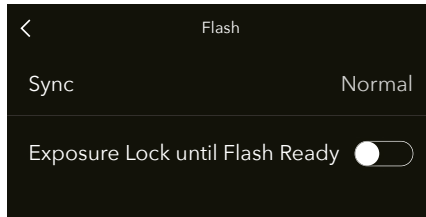

### Sync

Main Menu > Flash > Sync

Set to trigger the flash at the beginning or end of the exposure.

Normal: To trigger at the beginning of the exposure.

Rear: To trigger at the end of the exposure.

### Exposure Lock until Flash Ready

Main Menu > Flash > Exposure Lock until Flash Ready

Set whether to block a capture if the flash is not ready. If enabled, the capture will be blocked. While disabled, the capture will be allowed.

### 3.7 CAMERA BODY SETTINGS

This menu will appear when using with the 907X.

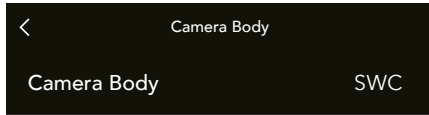

Main Menu > Camera Body > Camera Body

Select the camera body and the corresponding model will be displayed on Control Screen.

## 3.8 DISPLAY SETTINGS

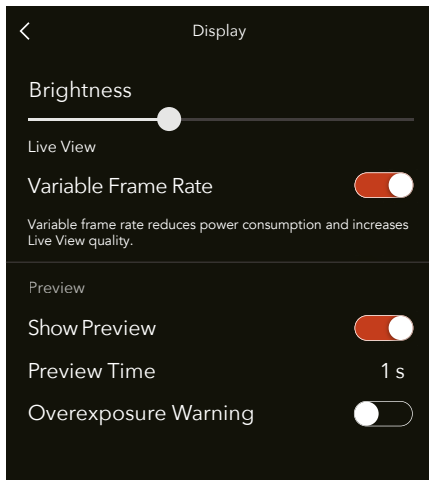

### Screen Brightness

Main Menu > Display > Screen Brightness

Slide the slider to adjust the brightness of the touch display.

### Live View

Main Menu > Display > Live View

### Variable Frame Rate

Variable frame rate reduces power consumption and increases Live View quality in weak lighting conditions.

## Preview

Main Menu > Display > Preview

When using with the 907X camera body or other cameras with the camera body set to Any (Electronic Shutter), enable preview, set the preview time, and then the touch display will show the preview of the captured image for the preset time after exposure.

### Show Preview

The touch display will show the preview after exposure.

### Preview Time

When it is set to 0.5s, 1s, 2s, 4s, or 8s, the display will return to Live View after the preset time.

When it is set to Hold, the display will stay in Browse Mode until users change to a different screen.

### Overexposure Warning

If enabled during preview, the overexposure areas in the image will flash as an indication.

## 3.9 POWER SETTINGS

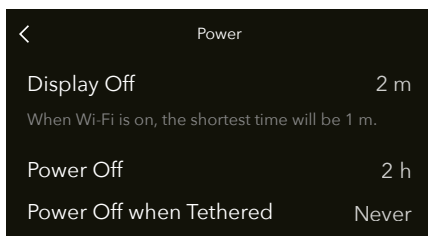

### Display Off

Main Menu > Power > Display Off

The display will be off if no operation is performed on the camera within the display-off time.

### Power Off

Main Menu > Power > Power Off

The camera will power off automatically if no operation is performed on the camera within this power-off time. If Never is selected, the camera will stay powered on.

### Power Off when Tethered

Main Menu > Power > Power Off when Tethered

When powering the camera using a USB-C cable, the camera will power off automatically if no operation is performed on the camera within this preset time. If Never is selected, the camera will stay powered on.

## 3.10 STORAGE SETTINGS

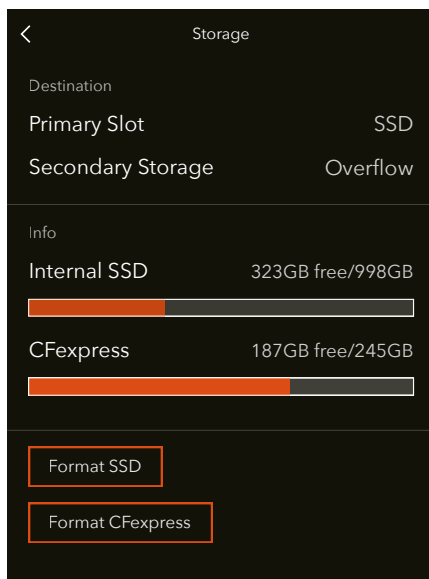

### Destination

Main Menu > Storage > Destination

Set usage for the built-in SSD and CFexpress memory card.

### Primary Slot

Select SSD or CFe as the primary storage and the other one as the secondary storage.

### Secondary Storage

If Overflow is selected, the camera will store images in the secondary storage when the preset primary storage is full.

If Backup (Images) is selected, the camera will store images to both the primary and secondary storage simultaneously.

## Info

Main Menu > Storage > Info

Displays the volume and available space of the built-in SSD and the CFexpress memory card inserted.

## Format

Main Menu > Storage > Format SSD

Tap to format the built-in SSD.

Main Menu > Storage > Format CFe

Tap to format the inserted memory card.



- Formatting will erase all the contents on the SSD or memory card. Operate with caution.

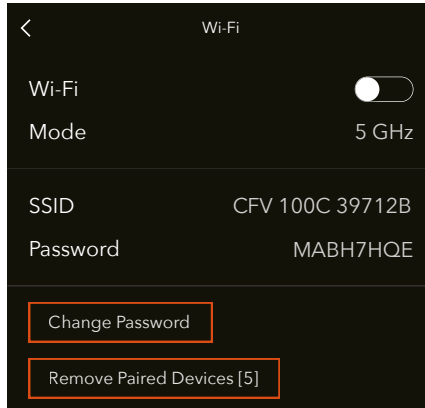

## 3.1.1 WI-FI SETTINGS

**Wi-Fi:**

Enable or disable Wi-Fi. If enabled, Bluetooth on the camera will also be enabled automatically, and the WLAN icon  will appear in the upper left corner of Control Screen or Main Menu.

**Mode:**

Select from 2.4 GHz or 5 GHz.

**SSID:**

Displays the Wi-Fi name of camera.

**Password:**

Displays the Wi-Fi password of camera.

**Change Password:**

Tap to refresh the Wi-Fi password.

**Remove Paired Devices:**

This can remove all devices that are paired and connected automatically through Bluetooth to the Phocus Mobile 2 app. The value in the brackets indicates the number of paired devices.

Tap this button on the touch display and press the browse button under the touch display to confirm or press the delete button to exit.

If the Remove Paired Devices button is grey on the touch display, it indicates that there were no devices paired before.



- Options for the Wi-Fi mode vary by country or region. Refer to local laws and regulations.

## 3.1.2 GENERAL SETTINGS

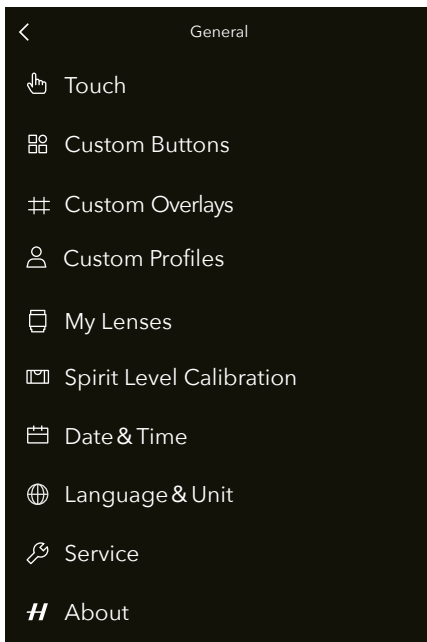

### Touch

When using with the 907X camera body, touch settings are available.

Main Menu > General > Touch

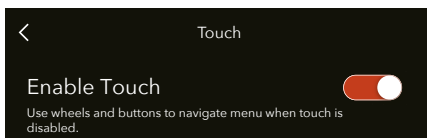

### Enable Touch

When disabled, all the touch operations on the touch display do not respond. Use the front and rear scroll wheels and the function button and control dial on the 907X camera body to control the menus and set parameters.

## Custom Buttons

When using the CFV 100C with the 907X camera body and 907X control grip, customise the buttons on the 907X control grip. Users can also customise the lens control ring when using some specific lenses.

Main Menu > General > Custom Buttons

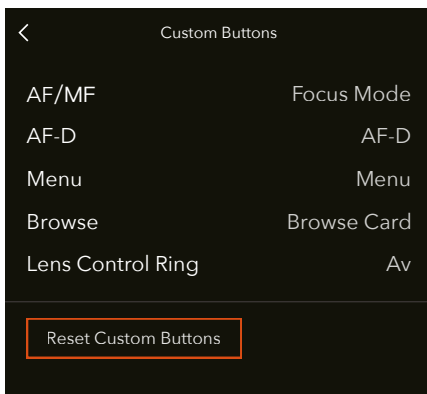

### Custom Buttons

The default functions are listed below. Users can change the settings to preferred functions.

AF/MF Button (AF/MF): Focus mode switch by default.

AF Drive Button (AF-D): Start autofocus by default.

Menu Button: Enter Main Menu by default. The display will enter Control Screen if Main Menu is displayed.

Browse Button: Enter Browse mode by default.

Lens Control Ring: Aperture adjustment by default. Only some specific lenses have this control ring.

### Reset Custom Buttons

Reset the functions for all the custom buttons to the factory settings. Tap the Reset Custom Buttons button on the touch display and press the browse button under the touch display to confirm or press the delete button to exit.

## Custom Overlays

Main Menu > General > Custom Overlays

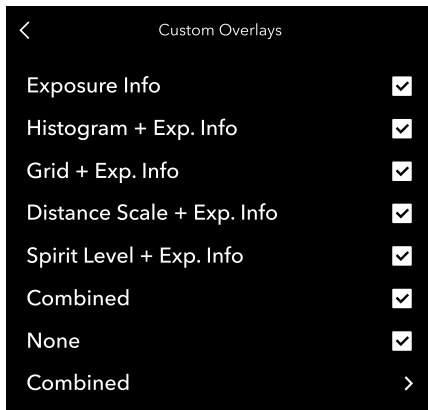

Set the selectable overlays displayed in Live View. In Live View, press the circle button under the touch display to switch between the options selected in this menu.

### Combined

In the Custom Overlays settings, scroll to the bottom, tap Combined to customise multiple overlays displayed in Live View.

For example, when Exposure Info, Histogram, and Grid are checked in this settings page, and Combined is also checked in the Custom Overlays settings, users can switch to the combined overlays (Exposure Info + Histogram + Grid) in Live View.

## Custom Profiles

Main Menu > General > Custom Profiles

Preset parameters for the camera and save them in different custom profiles. Users can enter the preset mode quickly and use the preset parameters for shooting to improve efficiency by using this function.

After parameter configuration, tap the number of the desired profile and tap Save to save the settings to the selected custom profile.

To use the profile, tap the corresponding profile and tap Load to apply the settings in the profile.



- Some camera settings, such as language, will not be saved to the custom profile.

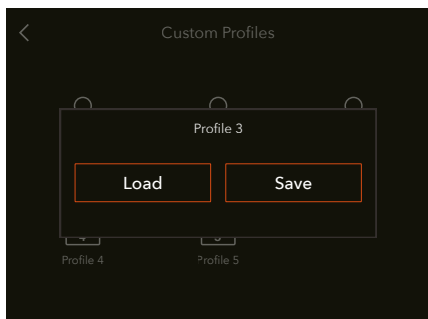
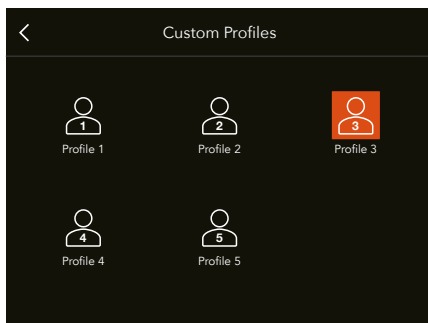

## My Lenses

Main Menu > General > My Lenses

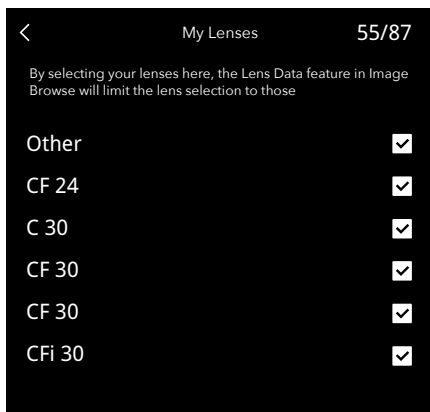

When using the CFV 100C with cameras other than the 907X, select the lenses here and the list of lenses for the lens data function in Browse mode will be limited to the selected models in this setting. Refer to the Image Browse section for more details about the lens data function.

## Spirit Level Calibration

Main Menu > General > Spirit Level Calibration

The camera is equipped with an accelerometer to measure the tilt of the camera relative to the horizontal axis and vertical axis. Spirit level calibration can assist in checking the tilt angle of the camera.



- In Live View, users can also enter spirit level calibration. Press the circle button under the touch display to switch the display until Exposure Information + Spirit Level appears.

### Calibration Modes

There are two modes for the spirit level, Default and Custom. Tap the icon on the upper left corner to select. Default Mode uses the standard factory settings. In Custom Mode, users can set the standard.

### Setting Custom Mode

1. Tap the icon on the upper left corner and tap Custom in the pop-up dialogue.
2. Adjust the camera horizontally and vertically to the desired position and tap Calibrate.
3. The two white circles are now moved to the centre position and turn green, indicating that the new spirit level standard is set.

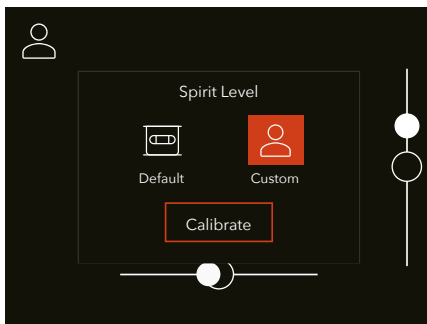

### Calibration Instructions

1. Tap the icon on the upper left corner and tap Default or Custom in the pop-up dialogue.
2. Adjust the tilt of the camera left/right and up/down until the solid white circle is in the centre and turns green.



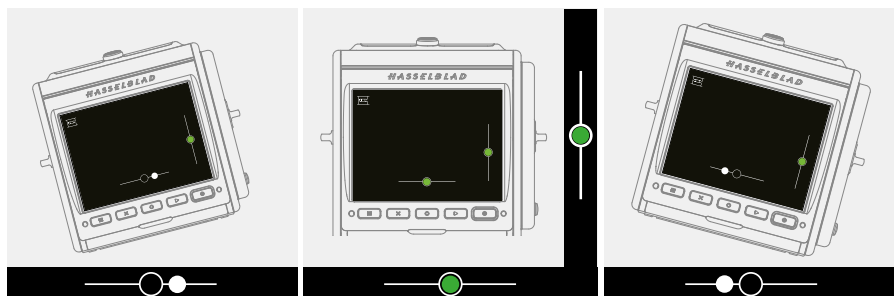

Camera tilted to the left.

Camera aligned horizontally and vertically.

Camera tilted to the right.

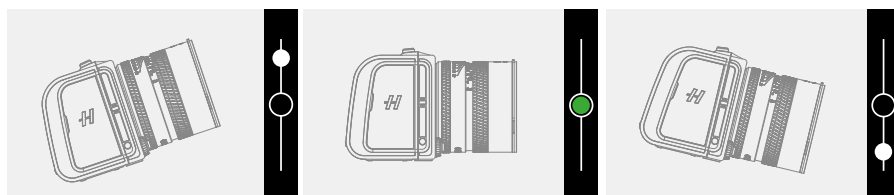

Camera tilted up.

Camera aligned vertically.

Camera tilted down.

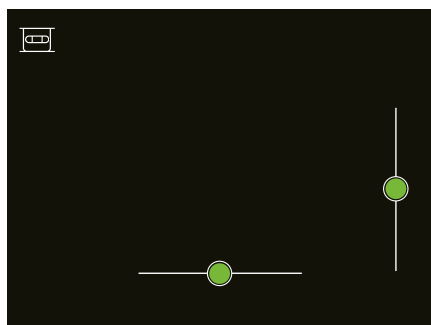

Spirit Level when camera is aligned.

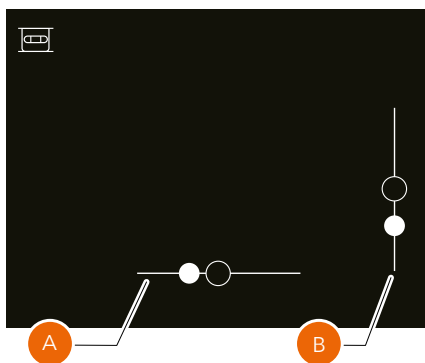

Spirit Level when camera is tilted a little to the right and more down.

## Date & Time

Main Menu > General > Date & Time

Tap Date or Time and select year, month, day, hour, and minute respectively.



## Language & Unit

Main Menu > General > Language & Unit

### Language

Tap Language and select the desired language from the list. Tap any other area on the screen to save the setting.

The following languages are supported:

- English
- Spanish
- French
- German
- Italian
- Swedish
- Russian
- Japanese
- Simplified Chinese
- Traditional Chinese
- Korean

### Unit of Distance

Select the unit displayed for the distance scale between metre and foot.

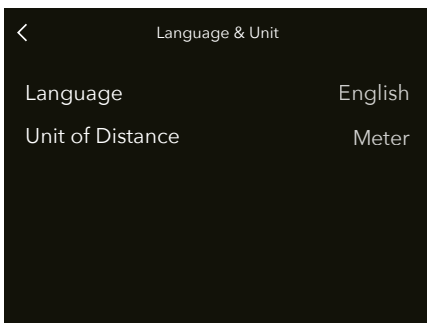

## Service

Main Menu > General > Service

### Firmware Update

Check the firmware version of the camera and lens.

Follow the instructions below to update the firmware on this page when new firmware is released.

1. Visit the official Hasselblad website [www.hasselblad.com](http://www.hasselblad.com) to download the latest firmware.
2. Store the firmware in the root directory of the camera SSD or CFexpress memory card.



- If using the camera SSD, make sure to tap Mass Storage in the dialogue on the touch display after the camera is connected to the computer, and then store the firmware to the camera.
- If using a memory card, make sure the memory card is inserted properly into the camera.

3. Power on the camera, go to Main Menu > General > Service and tap Check for Update.
4. Select the firmware file. Make sure that the name and version number of the firmware selected are the same as the downloaded version.
5. Tap Update, and the update dialogue appears. Tap Update in the dialogue to start the firmware update.

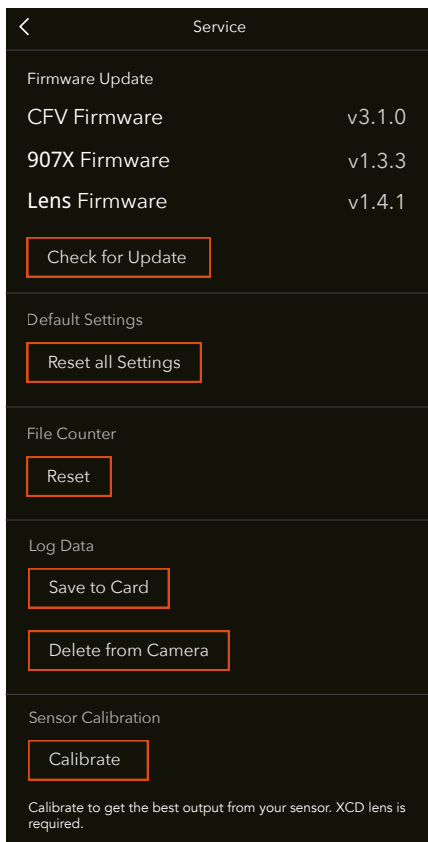

6. The camera will update firmware automatically. It will take several minutes for the update to complete. DO NOT power off the camera or remove the memory card if in use during an update.
7. The camera will show information for a successful update after completed.
8. In the Service screen, check and confirm that the firmware is the latest version.

## Default Settings

Reset all Settings: Reset all the settings except custom profiles to the default settings. If the box for Reset Profiles in the pop-up menu is checked, all the settings including custom profiles will be reset to the default settings.

## File Counter

Tap Reset and press the corresponding button under the touch display. The next captured images will be numbered B0000001.



- After resetting the file counter, if there are images present on the currently used storage, a new folder will be created in the storage in use and set as the default storage folder to avoid images using the same number. The pop-up window after reset will display the name of the new folder. All the images captured after this will be stored in the new folder.
- When the secondary storage is set for backup in the Storage settings, a new folder, if required during reset, will be created in both the built-in SSD and memory card.

## Log Data

The log data is the internal data of the camera for repair that can be used by Hasselblad technical support. Users can save or delete the log data using the buttons on the touch display.

Save to Card: Tap to save the current log data to the memory card or camera SSD if a memory card is not used. DO NOT remove the memory card or power off the camera when saving the log.

Delete from Camera: Tap to delete the saved log data from the camera.

## Sensor Calibration

Calibrate to get the optimal output from the sensor when using the 907X camera body and XCD lens.

Make sure that the battery level is more than 80%. Tap Calibrate, follow the onscreen instructions, and wait for the calibration to be completed.

## About

### Main Menu > General > About

View the product name, model number, and serial number.

Tap Licenses to view the electronic licenses.

Tap Usage to view the total number of lens exposures of the current lens.

Scroll to view Compliance Info, such as electronic labels and ID.

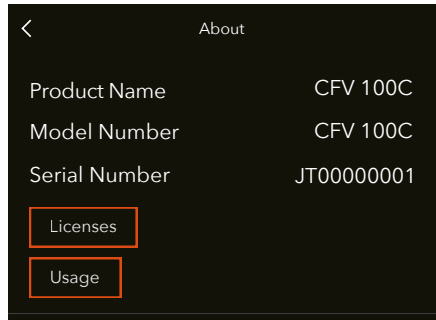

## 4 PHOCUS MOBILE 2 AND PHOCUS

## 4.1 PROFILE

The Phocus Mobile 2 app and Phocus software both use HNCS to deliver correct colours.

Expanding the possibilities of the Hasselblad workflow, Phocus Mobile 2 takes the image editing process to a new, portable level, enabling the travelling or studio photographer to have a quicker, more seamless workflow.

Phocus is an image processing and file management application aimed primarily at Hasselblad RAW 3F file handling. Phocus is a license-free software available for both Mac and Windows.

Visit the link below to download Phocus Mobile 2 and Phocus.

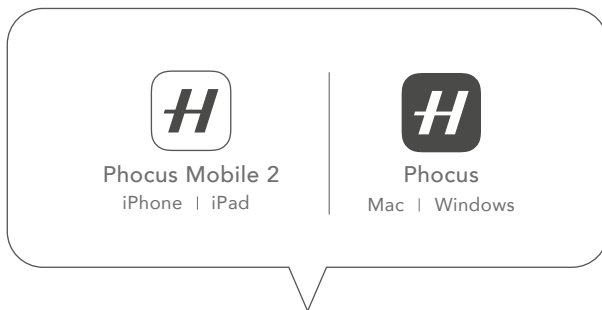

<https://www.hasselblad.com/my-hasselblad/907x-cfv100c-qr>

## 4.2 PHOCUS MOBILE 2 APP



To use Phocus Mobile 2, connect the camera to an iOS device using Wi-Fi. Users can import, edit, and rate RAW and full-quality JPG images directly on the device. Phocus Mobile 2 supports full-quality image export, tethered shooting, and camera control.

Phocus Mobile 2 is compatible with iPad models and iPhone Xs or above with more than 3GB of RAM running on iOS 15.0 or later.

Visit the official Hasselblad website for more information.

<https://www.hasselblad.com/phocus/phocus-mobile-2>



## 4.3 PHOCUS SOFTWARE

### Connecting to Computer



Connect the USB-C port on the camera to a computer using a USB-C cable of USB 2.0 or above. Users can control the camera remotely in Phocus, such as aperture adjustment or exposure time control.

Phocus is compatible with computers with 8GB of RAM or more running on macOS 10.15 or later, or Windows 7 64-bit or later.

When initiating a shot from Phocus, the computer sends a signal to the camera to trigger the shutter and the flash if it is in use. The camera sends the image over the USB connection to the computer, where it is displayed. The image is saved as a 16-bit 3F file in the currently selected folder on the computer hard disk for post-processing, such as colour and exposure adjustment.

Visit the official Hasselblad website for more information.  
<https://www.hasselblad.com/phocus>



When connected to a computer, the following applies:

- After connecting to the computer, make sure to tap Skip in the pop-up dialogue on the camera touch display to use tethered shooting.
- The destination medium and location are controlled by the Phocus software. The images cannot be saved to the camera.
- All exposure settings, including ISO, aperture, and shutter speed, are controlled from the Phocus software if users choose to expose from Phocus.

## Professional Image Quality

Phocus combines Hasselblad Natural Colour Solution (HNCS) with Digital Auto-Correction (DAC) to provide high digital image quality for the images users create. With Phocus, the moiré effect that can occur on extremely high-resolution images is effectively removed automatically and directly on the raw data, leaving the image quality intact and saving time in post-production.

## Phocus and Hasselblad Capture Files



The digital back can capture files and store them as Hasselblad RAW format files.

Hasselblad RAW files are initially stored in the 3FR format, which is a proprietary Hasselblad format for the temporary storage of images. A 3FR file contains the complete digitised raw image exactly. 3FR information requires further computing power (typically by way of Phocus) to obtain complete development. If developed in Phocus, 3FR files become Hasselblad 3F files with the suffix ".fff". If developed by other RAW processors, the 3FR files will not be converted to 3F but can be exported directly to TIFF and PSD according to requirements.

## 5 APPENDIX

## 5.1 CHANGE FROM FOREIGN LANGUAGE

Main Menu > General > Language & Unit

1. Power on the camera and press the menu button twice to enter Main Menu.
2. Tap the general settings icon .
3. Scroll on the screen to find the globe icon .
4. Tap to enter the language setting page and tap to select the desired language from the list.

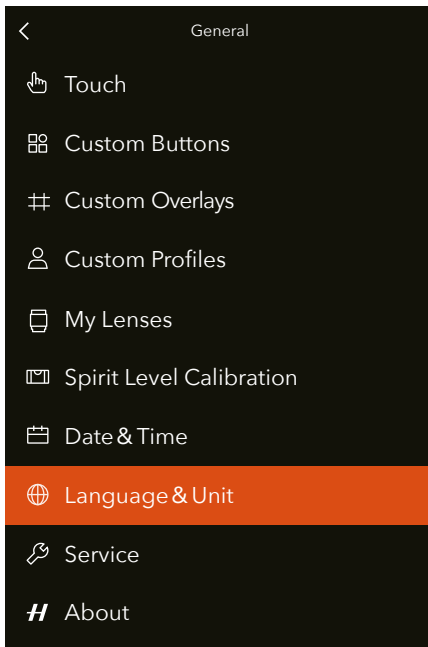

Language Menu

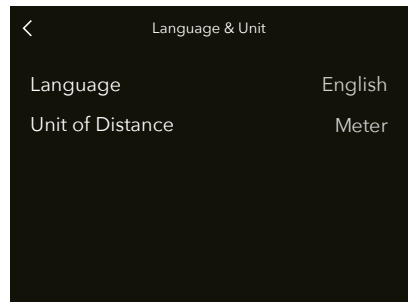

Language Setting

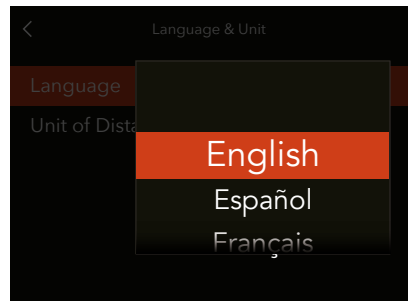

## 5.2 ERROR MESSAGES

If any error message is displayed

1. Remove the components from the camera.
2. Attach the components to the camera again.

If the error message is still displayed

1. Remove the battery.
2. Remove any connected USB cable.
3. Wait 10 seconds.
4. Attach the battery again.

The camera processor is now reset.

If the error message is still displayed

1. Write down the error message.
2. Contact your closest authorized Hasselblad dealer.

## 5.3 CLEAN THE SENSOR FILTER

Follow the instructions below:

1. Power off the camera and remove any device or cable, if connected.
2. Detach the digital back from the connected device.
3. Carefully clean the outside surface of the IR filter using canned compressed air.
4. Mount the digital back to the camera or mount the protective covers to the digital back and camera.

Take several shots of multiple images to test, and then check each image carefully. Contact the Hasselblad authorised service centre if there are any spots on the images.



- Be careful when attaching/removing the components to/from the camera. This will help prevent damage to the data bus connections.
- After removing the lens, keep foreign objects away from the camera opening. The camera opening is very sensitive. This will help prevent damage to the equipment.
- If using canned compressed air to clean the glass of the IR filter, read the instructions carefully before use. This will help prevent damage to the filter.
- DO NOT remove the glass IR filter from the front of the sensor. This will cause damage to the equipment. Contact the Hasselblad authorised service centre if needed.

## 5.4 CLEAN THE LENS GLASS SURFACE

### Remove Dust

Remove the dust with an air blower or a very soft lens brush.

### Remove Smear

If there is smear on the lens glass, do as follows:

1. If you are not sure how to remove the smear, contact the Hasselblad authorised service centre.
2. Clean the lens glass with a high quality lens cleaning solution on a tissue.

## 5.5 CLEAN THE DIGITAL BACK



- Avoid using organic solvents to wipe the leather on the digital back, as this may cause discolouration of the leather.
1. Clean the metal body and leather surface of the digital back with a clean, soft cotton cloth.
  2. Clean the screen with a high-quality lens cleaning wipe.

## 5.6 EV VALUE

The EV value (Exposure Value) represents a combination of aperture and shutter speed where all combinations giving the same exposure will have the same EV value.

As an example:

$f/5.6 - 1/125s$  and  $f/4 - 1/250s$  has the same EV value = 12.

If the users press AE-L in manual exposure mode and rotate either or both scroll wheels, aperture and shutter speed will change, but the EV value will remain the same.

A change of the EV value by one is the same as changing aperture or shutter speed by one stop.

Examples:

$f/5.6 - 1/125s$ : EV 12

$f/8 - 1/125s$ : EV 13

$f/5.6 - 1/250s$ : EV 13

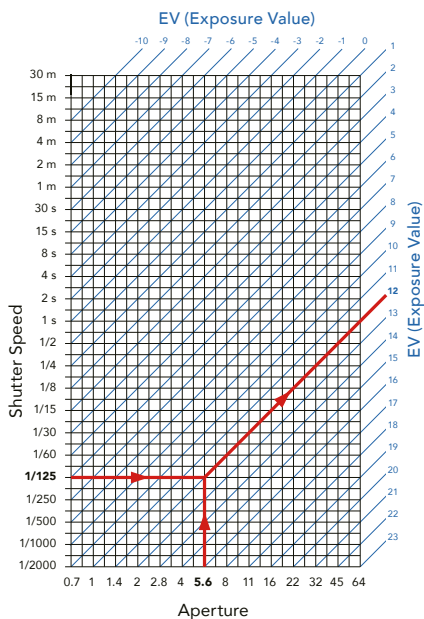

It is important to understand that although two images that were made using the same EV value but with different combinations of aperture and shutter speed will have the same exposure but will not be identical due to different depth-of-field and movement stopping time.

As the EV value is related to the lighting conditions, it can in many cases be an easy way to quickly set the correct exposure. As a start users can use the following guidelines.

Scene	EV Value @ISO 100
Light sand or snow with clear shadows	16
Outdoor scene in direct sunlight	15
Outdoor scene, Cloudy no shadows	13
Outdoor scene in shadows, clear sunlight	12
Sunset	12
Night scenes in city lights	7-8
Indoor, home	5-7

The table shows EV values for ISO 100. If using another ISO setting the EV value should be modified as follows:

ISO 64: EV -2/3

ISO 200: EV +1

ISO 400: EV +2

ISO 800: EV +3

and so forth.

More information here: [https://en.wikipedia.org/wiki/Exposure\\_value](https://en.wikipedia.org/wiki/Exposure_value)



## 5.7 ACCESSORIES

### XH Lens Adapter

CP.QT.00000290.01

The XH Lens Adapter can be used to mount an HC/HCD lens onto the 907X & CFV 100C camera.

The XH Lens Adapter widens the 907X & CFV 100C lens choices to include all 12 H-system HC/HCD lenses, and accessories including a macro converter and 3 extension tubes.

The HC/HCD lens range includes a 24 mm wide-angle lens, a 300 mm telephoto lens and a 100 mm f 2.2 lens, delivering small depth-of-field range and a beautiful, smooth Bokeh.



- Only certain functions of the camera are supported when using an H System lens.



## XH Converter 0,8

CP.HB.00000627.01

The XH Converter 0,8 is an accessory for using HC/HCD lenses on X System cameras. It reduces the focal length of the attached lens by a factor of 0,8x as well as increases the maximum and minimum aperture with 2/3 stops.

The following cameras and lenses are supported:

- Hasselblad X System cameras, X2D 100C with firmware 1.0.0 or later, X1D 50C with firmware 1.25.0 or later, or X1D II 50C with firmware 1.4.0 or later.
- Hasselblad V System cameras, CFV 100C with firmware 3.1.0 or later, 907X/CFV II 50C with firmware 1.4.0 or later.
- All Hasselblad HC and HCD lenses, except HC120 and HC120-II with firmware older than 18.0.0.



- Only certain functions of the camera are supported when using an H System lens.
- Lenses with firmware 18.0.0 to 19.0.3 must be updated to 19.1.0 or later. Lenses with firmware older than 18.0.0 will have manual focus only.
- HCD lenses were originally designed for a smaller format than HC lenses. Therefore some reduction of performance in extreme corners can occur.

## XV Lens Adapter

CP.HB.00000241.01

The XV lens Adapter is used to attach Hasselblad V System lenses to the 907X & CFV 100C. Compatible with all V System lenses (C, CF, CFi, CFE, CB, F and FE)



- This requires the electronic shutter function of the 907X & CFV 100C to be activated.
- Lens corrections for V System lenses are available with Phocus version 3.4 or later. Note that they have to be manually selected.



## Tripod Mount Ring 75mm

CP.HB.00000217.01

The tripod mount ring is designed to fit the XH/XV lens adapters and the X Converter 1.7, giving additional support when using long or heavy HC/HCD or V System lenses on 907X & CFV 100C. The tripod mount ring can be fitted to 1/4" and 3/8" tripod threads or the Hasselblad Quick Coupling Plate H.



## XPan Lens Adapter

CP.HB.00000036.01

The XPan Lens Adapter is used to attach lenses that was made for the XPan camera. Available XPan lenses were 5,6/30mm, 4/45mm and 4/90mm.



- XPan Lenses had no built-in shutter. Consequently, they can only be used when the electronic shutter of the camera is activated.



## Battery Charging Hub

CP.HB.00000397.01 (EMEA)

CP.HB.00000395.01 (United Kingdom)

CP.HB.00000392.01 (North America/Japan)

CP.HB.00000396.01 (China)

CP.HB.00000393.01 (South Korea)

CP.HB.00000394.01 (Australia/New Zealand)



Streamlining the battery charging process, the Hasselblad Battery Charging Hub contains dual slots that support the simultaneous charging of two batteries. An integrated USB Type-C connector supports mains power via an included power supply or from common external USB battery banks (purchased separately). Front-facing LEDs indicate status and capacity when charging, or users can use the Battery Charging Hub to check battery levels simply by inserting a battery and pressing a single button.

## Release Cord X

CP.HB.00000242.01

The Hasselblad Release Cord X allows for remote shutter control in Electronic Shutter mode on the CFV 100C, helping to eliminate shake or vibration. A durable cloth-wrapped 90cm (36in.) cable connects to the shutter control port of the CFV 100C and the simple single button operation allows photographers to keep vibration to a minimum. Its durable metal construction combined with its slim, ergonomic design fits comfortably in the hand. Release Cord X comes with a small leather carry pouch.



## Flash Sync Input Cable

No. CP.QT.HB000184.01

This cable is used to connect the flash sync of a lens to the CFV for exposure synchronization.



## Flash Sync Output Cable

No. CP.QT.HB000182.01

For connection of an external flash to the flash sync output of the CFV.



## Exposure Cable EL

No. CP.QT.HB000183.01

Cable for exposure remote control of an EL type camera using Phocus. Not required for 555ELD.



## Exposure Cable 503

No. CP.QT.HB000181.01

Cable for exposure remote control of a 503CW camera with Winder CW using Phocus.



## V System Accessories

The V System was manufactured for many years and included a large number of accessories. Although all have been discontinued a long time ago, many can still be found second-hand.

A few accessories to mention that will improve the use of V System cameras are the Prism Viewfinders that were available with or without built-in light metering. For the 500C, 500C/M and 503CX cameras a special winding knob with built-in light metering was also available.

It is also worth mentioning that the 202FA, 203FE, 205TCC and 205FCC cameras had built in light metering and featured auto-exposure.

For in-depth information about Hasselblad cameras and accessories from the very beginning, the book "Hasselblad Compendium" by Richard Nordin is highly recommended.



PME



PME 45



PME 90



Knob with exposure meter

This content is subject to change without notice.  
Download the latest version from



<https://www.hasselblad.com/my-hasselblad/downloads>

HASSELBLAD and **H** are trademarks of Victor Hasselblad AB.

Copyright ©2024 Victor Hasselblad AB. All Rights Reserved.